



Considering Cumulative Effects Under the National Environmental Policy Act (CEQ, 1997)

[Home](#) » [Considering Cumulative Effects Under the National Environmental Policy Act \(CEQ, 1997\)](#)

This handbook presents the results of research and consultations by the Council on Environmental Quality concerning the consideration of cumulative effects in analyses prepared under the National Environmental Policy Act (NEPA). It introduces the NEPA practitioner and other interested parties to the complex issue of cumulative effects, outlines general principles, presents useful steps, and provides information on methods of cumulative effects analysis and data sources.

 [Considering Cumulative Effects Under the National Environmental Policy Act](#)

1000 Independence Avenue, S.W.
Washington, DC 20585
Phone: 202-586-4600
Phone: 1-800-472-2756
Email: askNEPA@hq.doe.gov

An office of

ABOUT NEPA

Careers & Internships

Guidance & Requirements

ENERGY.GOV RESOURCES

Budget & Performance

Directives, Delegations & Requirements

FOIA

Inspector General

Privacy Program

Small Business

Staff & Contractor Resources

FEDERAL GOVERNMENT

The White House

USA.gov

[Web Policies](#) • [Privacy](#) • [No Fear Act](#) • [Whistleblower Protection](#) • [Information Quality](#) •
[Open Gov](#) • [Accessibility](#)

Considering Cumulative Effects

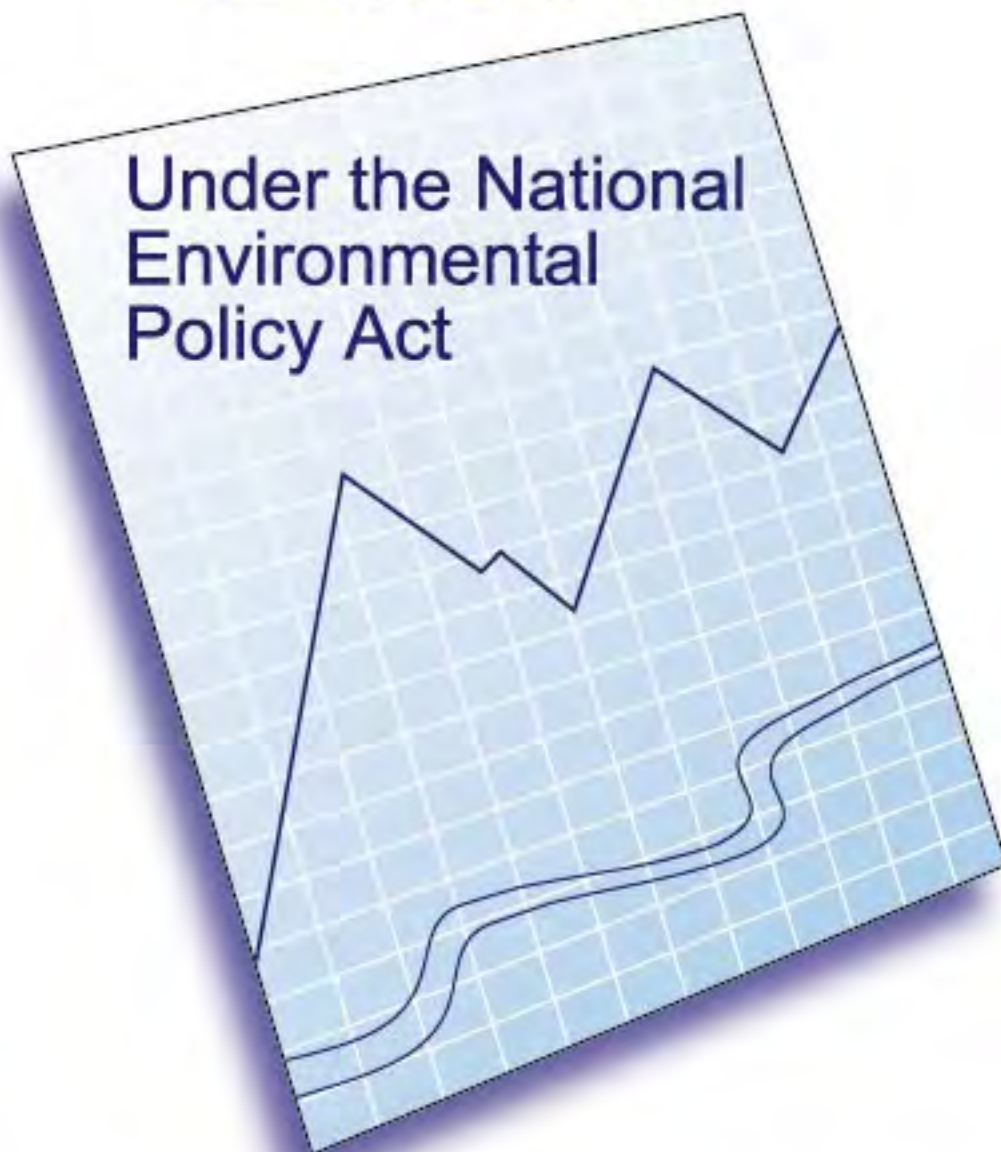

Council on Environmental Quality
Executive Office of the President

Visited on 10/23/2018

Considering Cumulative Effects Under the National Environmental Policy Act

Council on Environmental Quality

January 1997

TABLE OF CONTENTS

EXECUTIVE SUMMARY

1 INTRODUCTION TO CUMULATIVE EFFECTS ANALYSIS	1
Purpose of Cumulative Effects Analysis	2
Agency Experience with Cumulative Effects Analysis	3
Principles of Cumulative Effects Analysis	7
How Environmental Effects Accumulate	7
Roadmap to the Handbook	10
2 SCOPING FOR CUMULATIVE EFFECTS	11
Identifying Cumulative Effects Issues	11
Bounding Cumulative Effects Analysis	12
Identifying Geographical Boundaries	12
Identifying Time Frames	16
Identifying Past, Present, and Reasonably Foreseeable Future Actions	16
Agency Coordination	20
Scoping Summary	21
3 DESCRIBING THE AFFECTED ENVIRONMENT	23
Components of the Affected Environment	24
Status of Resources, Ecosystems, and Human Communities	26
Characterization of Stress Factors	27
Regulations, Administrative Standards, and Regional Plans	29
Trends	31
Obtaining Data for Cumulative Effects Analysis	31
Affected Environment Summary	34
4 DETERMINING THE ENVIRONMENTAL CONSEQUENCES OF CUMULATIVE EFFECTS	37
Confirming the Resources and Actions to be Included in the Cumulative Effects Analysis	37
Identifying and Describing Cause-and-Effect Relationships for Resources, Ecosystems, and Human Communities	38
Determining the Environmental Changes that Affect Resources	38
Determining the Response of the Resource to Environmental Change	40
Determining the Magnitude and Significance of Cumulative Effects	41
Determining Magnitude	42
Determining Significance	44
Avoiding, Minimizing, and Mitigating Significant Cumulative Effects	45
Addressing Uncertainty Through Monitoring and Adaptive Management	46

5 METHODS, TECHNIQUES, AND TOOLS FOR ANALYZING CUMULATIVE EFFECTS	49
Literature on Cumulative Effects Analysis Methods	49
Implementing a Cumulative Effects Analysis Methodology	50

REFERENCES	59
-------------------------	-----------

APPENDICES:

Appendix A. Summaries of Cumulative Effects Analysis Methods

Appendix B. Acknowledgements

Visited on 10/23/2018

Considering Cumulative Effects Under the National Environmental Policy Act

Council on Environmental Quality

January 1997

PREFACE

This handbook presents the results of research and consultations by the Council on Environmental Quality (CEQ) concerning the consideration of cumulative effects in analyses prepared under the National Environmental Policy Act (NEPA). It introduces the NEPA practitioner and other interested parties to the complex issue of cumulative effects, outlines general principles, presents useful steps, and provides information on methods of cumulative effects analysis and data sources. The handbook does not establish new requirements for such analyses. It is not and should not be viewed as formal CEQ guidance on this matter, nor are the recommendations in the handbook intended to be legally binding.

EXECUTIVE SUMMARY

The Council on Environmental Quality's (CEQ) regulations (40 CFR §§ 1500 - 1508) implementing the procedural provisions of the National Environmental Policy Act (NEPA) of 1969, as amended (42 U.S.C. §§ 4321 *et seq.*), define cumulative effects as

the impact on the environment which results from the incremental impact of the action when added to other past, present, and reasonably foreseeable future actions regardless of what agency (Federal or non-Federal) or person undertakes such other actions (40 CFR § 1508.7).

Although the regulations touch on every aspect of environmental impact analysis, very little has been said about cumulative effects. As a result, federal agencies have independently developed procedures and methods to analyze the cumulative effects of their actions on environmental resources, with mixed results.

The CEQ's "Considering Cumulative Effects Under the National Environmental Policy Act" provides a framework for advancing environmental impact analysis by addressing cumulative effects in either an environmental assessment (EA) or an environmental impact statement (EIS). The handbook presents practical methods for addressing coincident effects (adverse or beneficial) on specific resources, ecosystems, and human communities of all related activities, not just the proposed project or alternatives that initiate the assessment process.

In their environmental analyses, federal agencies routinely address the direct and (to a lesser extent) indirect effects of the proposed

action on the environment. Analyzing cumulative effects is more challenging, primarily because of the difficulty of defining the geographic (spatial) and time (temporal) boundaries. For example, if the boundaries are defined too broadly, the analysis becomes unwieldy; if they are defined too narrowly, significant issues may be missed, and decision makers will be incompletely informed about the consequences of their actions.

The process of analyzing cumulative effects can be thought of as enhancing the traditional components of an environmental impact assessment: (1) scoping, (2) describing the affected environment, and (3) determining the environmental consequences. Generally it is also critical to incorporate cumulative effects analysis into the development of alternatives for an EA or EIS. Only by reevaluating and modifying alternatives in light of the projected cumulative effects can adverse consequences be effectively avoided or minimized. Considering cumulative effects is also essential to developing appropriate mitigation and monitoring its effectiveness.

In many ways, scoping is the key to analyzing cumulative effects; it provides the best opportunity for identifying important cumulative effects issues, setting appropriate boundaries for analysis, and identifying relevant past, present, and future actions. Scoping allows the NEPA practitioner to "count what counts." By evaluating resource impact zones and the life cycle of effects rather than projects, the analyst can properly bound the cumulative effects analysis. Scoping can also facilitate the interagency cooperation needed to identify agency plans and other

actions whose effects might overlap those of the proposed action.

When the analyst describes the affected environment, he or she is setting the environmental baseline and thresholds of environmental change that are important for analyzing cumulative effects. Recently developed indicators of ecological integrity (e.g., index of biotic integrity for fish) and landscape condition (e.g., fragmentation of habitat patches) can be used as benchmarks of accumulated change over time. In addition, remote sensing and geographic information system (GIS) technologies provide improved means to analyze historical change in indicators of the condition of resources, ecosystems, and human communities, as well as the relevant stress factors. Many dispersed local information sources and emerging regional data collection programs are now available to describe the cumulative effects of a proposed action.

Determining the cumulative environmental consequences of an action requires delineating the cause-and-effect relationships between the multiple actions and the resources, ecosystems, and human communities of concern. Analysts must tease from the complex networks of possible interactions those that substantially affect the resources. Then, they must describe the response of the resource to this environmental change using modeling, trends analysis, and scenario building when uncertainties are great. The significance of cumulative effects depend on how they compare with the environmental baseline and relevant resource thresholds (such as regulatory standards). Most often, the historical context surrounding the resource is critical to developing these baselines and thresholds and to supporting both imminent and future decision-making.

Undoubtedly, the consequences of human activities will vary from those that were predicted and mitigated. This will be even more problematic because of cumulative effects; therefore, monitoring the accuracy of predictions and

the success of mitigation measures is critical. Adaptive management provides the opportunity to combine monitoring and decision making in a way that will better ensure protection of the environment and attainment of societal goals.

Successfully analyzing cumulative effects ultimately depends on the careful application of individual methods, techniques, and tools to the environmental impact assessment at hand. There is a close relationship between impact assessment and environmental planning, and many of the methods developed for each are applicable to cumulative effects analysis. The unique requirements of cumulative effects analysis (i.e., the focus on resource sustainability and the expanded geographic and time boundaries) must be addressed by developing an appropriate conceptual model. To do this, a suite of primary methods can be used: questionnaires, interviews, and panels; checklists; matrices; networks and system diagrams; modeling; trends analysis; and overlay mapping and GIS. As with project-specific effects, tables and matrices can be used to evaluate cumulative effects (and have been modified specifically to do so). Special methods are also available to address the unique aspects of cumulative effects, including carrying capacity analysis, ecosystem analysis, economic impact analysis, and social impact analysis.

This handbook was developed by reviewing the literature and interviewing practitioners of environmental impact assessment. Most agencies that have recently developed their own guidelines for analyzing cumulative effects recognize cumulative effects analysis as an integral part of the NEPA process, not a separate effort. This handbook is not formal guidance nor is it exhaustive or definitive; it should assist practitioners in developing their own study-specific approaches. CEQ expects that the handbook (and similar agency guidelines) will be updated periodically to reflect additional experience and new methods, thereby, constantly improving the state of cumulative effects analysis.

new methods, thereby, constantly improving the state of cumulative effects analysis.

The handbook begins with an introduction to the cumulative effects problem and its relevance to the NEPA process. The introduction defines eight general principles of cumulative effects analysis and lays out ten specific steps that the NEPA practitioner can use to analyze cumulative effects. The next three chapters parallel the environmental impact assessment process and discuss analyzing cumulative effects while (1) scoping, (2) describing the affected environment, and (3) determining environmental consequences. Each component in the NEPA process is the logical place to complete necessary steps in cumulative effects analysis, but practitioners should remember that analyzing for cumulative effects is an iterative process. Specifically, the results of cumulative effects analysis can and should contribute to refining alternatives and

designing mitigation. Table E-1 illustrates how the principles of cumulative effects analysis can be the focus of each component of the NEPA process. Chapter 5 discusses the methods, techniques, and tools needed to develop a study-specific methodology and actually implement cumulative effects analysis. Appendix A provides summaries of 11 of these methods.

Cumulative effects analysis is an emerging discipline in which the NEPA practitioner can be overwhelmed by the details of the scoping and analytical phases. The continuing challenge of cumulative effects analysis is to focus on important cumulative issues, recognizing that a better decision, rather than a perfect cumulative effects analysis, is the goal of NEPA and environmental impact assessment professionals.

EIA Components	CEA Principles
Scoping	<ul style="list-style-type: none"> ● Include past, present, and future actions. ● Include all federal, nonfederal, and private actions. ● Focus on each affected resource, ecosystem, and human community. ● Focus on truly meaningful effects.
Describing the Affected Environment	<ul style="list-style-type: none"> ● Focus on each affected resource, ecosystem, and human community. ● Use natural boundaries.
Determining the Environmental Consequences	<ul style="list-style-type: none"> ● Address additive, countervailing, and synergistic effects. ● Look beyond the life of the action. ● Address the sustainability of resources, ecosystems, and human communities.

1

INTRODUCTION TO CUMULATIVE EFFECTS ANALYSIS

Evidence is increasing that the most devastating environmental effects may result not from the direct effects of a particular action, but from the combination of individually minor effects of multiple actions over time.

Some authorities contend that most environmental effects can be seen as cumulative because almost all systems have already been modified, even degraded, by humans. According to the report of the National Performance Review (1994), the heavily modified condition of the San Francisco Bay estuary is a result of activities regulated by a wide variety of government agencies. The report notes that one mile of the delta of the San Francisco Bay may be affected by the decisions of more than 400 agencies (federal, state, and local). William Odum (1982) succinctly described environmental degradation from cumulative effects as "the tyranny of small decisions."

The Council on Environmental Quality's (CEQ) regulations for implementing the National Environmental Policy Act (NEPA) define cumulative effects as

the impact on the environment which results from the incremental impact of the action when added to other past, present, and reasonably foreseeable future actions regardless of what agency (Federal or non-federal) or person undertakes such other actions (40 CFR § 1508.7).

The fact that the human environment continues to change in unintended and unwanted ways in spite of improved federal decisionmaking resulting from the implementation of NEPA is largely attributable to this incremental (cumulative) impact. Although past environmental impact analyses have focused primarily on project-specific impacts, NEPA provides the context and carries the mandate to analyze the cumulative effects of federal actions.

NEPA and CEQ's regulations define the cumulative problem in the context of the action, alternatives, and effects. By definition, cumulative effects must be evaluated along with the direct effects and indirect effects (those that occur later in time or farther removed in distance) of each alternative. The range of alternatives considered must include the no-action alternative as a baseline against which to evaluate cumulative effects. The range of actions that must be considered includes not only the project proposal but all connected and similar actions that could contribute to cumulative effects. Specifically, NEPA requires that all related actions be addressed in the same analysis. For example, the expansion of an airport runway that will increase the number of passengers traveling must address not only the effects of the runway itself, but also the expansion of the terminal and the extension of roadways to provide access to the expanded terminal. If there are similar actions planned

in the area that will also add traffic or require roadway extensions (even though they are nonfederal), they must be addressed in the same analysis.

The selection of actions to include in the cumulative effects analysis, like any environmental impact assessment, depends on whether they affect the human environment. Throughout this handbook discussion of the environment will focus on resources (entities such as air quality or a trout fishery), ecosystems (local or landscape-level units where nature and humans interact), and human communities (sociocultural settings that affect the quality of life). The term resources will sometimes be used to refer to all three entities. Table 1-1 lists some of the common cumulative

effects situations faced by federal agencies (see Chapter 3 for a list of common cumulative effects issues affecting various resources, ecosystems, and human communities).

PURPOSE OF CUMULATIVE EFFECTS ANALYSIS

Congressional testimony on behalf of the passage of NEPA stated that

...as a result of the failure to formulate a comprehensive national environmental policy... environmental problems are only dealt with when they reach crisis proportions..... Important decisions concerning the use and shape of man's environment continue to be made in small but steady increments which perpetuate requirements.

Table 1-1. Examples of cumulative effects situations faced by federal agencies including both multiple agency actions and other actions affecting the same resource

Federal Agency	Cumulative Effects Situations
Army Corps of Engineers	<ul style="list-style-type: none"> ■ incremental loss of wetlands under the national permit to dredge and fill and from land subsidence
Bureau of Land Management	<ul style="list-style-type: none"> ■ degradation of rangeland from multiple grazing allotments and the invasion of exotic weeds
Department of Defense	<ul style="list-style-type: none"> ■ population declines in nesting birds from multiple training missions and commercial tree harvests within the same land unit
Department of Energy	<ul style="list-style-type: none"> ■ increased regional acidic deposition from emissions trading policies and changing climate patterns
Federal Energy Regulatory Commission	<ul style="list-style-type: none"> ■ blocking of fish passage by multiple hydropower dams and Corps of Engineers reservoirs in the same river basin
Federal Highway Administration	<ul style="list-style-type: none"> ■ cumulative commercial and residential development and highway construction associated with suburban sprawl
Forest Service	<ul style="list-style-type: none"> ■ increased soil erosion and stream sedimentation from multiple timber permits and private logging operations in the same watershed
General Services Administration	<ul style="list-style-type: none"> ■ change in neighborhood sociocultural character resulting from ongoing local development including new federal office construction
National Park Service	<ul style="list-style-type: none"> ■ degraded recreational experience from overcrowding and reduced visibility

Interim guidelines issued in 1970 stated that the effects of many federal decisions about a project or complex of projects can be "individually limited but cumulatively considerable" (35 *Federal Register* 7391, May 12, 1970).

The passage of time has only increased the conviction that cumulative effects analysis is essential to effectively managing the consequences of human activities on the environment. The purpose of cumulative effects analysis, therefore, is to ensure that federal decisions consider the full range of consequences of actions. Without incorporating cumulative effects into environmental planning and management, it will be impossible to move towards sustainable development, i.e., development that meets the needs of the present without compromising the ability of future generations to meet their own needs (World Commission on Environment and Development 1987; President's Council on Sustainable Development 1996). To a large extent, the goal of cumulative effects analysis, like that of NEPA itself, is to inject environmental considerations into the planning process as early as needed to improve decisions. If cumulative effects become apparent as agency programs are being planned or as larger strategies and policies are developed then potential cumulative effects should be analyzed at that time.

Cumulative effects analysis necessarily involves assumptions and uncertainties, but useful information can be put on the decision-making table now. Decisions must be supported by the best analysis based on the best data we have or are able to collect. Important research and monitoring programs can be identified that will improve analyses in the future, but their absence should not be used as a reason for not analyzing cumulative effects to the extent possible now. Where substantial uncertainties remain or multiple resource objectives exist, adaptive management provisions for flexible project implementation can be incorporated into the selected alternative.

Sustainable America

President Clinton's Council on Sustainable Development was charged with recommending a national action strategy for sustainable development at a time when Americans are confronted with new challenges that have global ramifications. The Council adopted the Brundtland Commission's definition of sustainable development and articulated the following vision:

Our vision is of a life-sustaining Earth. We are committed to the achievement of a dignified, peaceful, and equitable existence. A sustainable United States will have a growing economy that provides equitable opportunities for satisfying livelihoods and a safe, healthy, high quality of life for current and future generations. Our nation will protect its environment, its natural resource base, and the functions and viability of natural systems on which all life depends.

The Council concluded that in order to meet the needs of the present while ensuring that future generations have the same opportunities, the United States must change by moving from conflict to collaboration and adopting stewardship and individual responsibility as tenets by which to live. This vision is similar to the first environmental policy listed in NEPA—that each generation should fulfill its responsibilities as trustee of the environment for succeeding generations. Analyzing for cumulative effects on the full range of resources, ecosystems, and human communities under NEPA provides a mechanism for addressing sustainable development.

AGENCY EXPERIENCE WITH CUMULATIVE EFFECTS ANALYSIS

Federal agencies make hundreds, perhaps thousands, of small decisions annually. Sometimes a single agency makes decisions on

similar projects; other times project decisions by many different authorities are interrelated. The Federal Energy Regulatory Commission must make licensing decisions on many individual hydropower facilities within the same river basin (Figure 1-1). The Federal Highway Administration and state transportation agencies frequently make decisions on highway projects that may not have significant direct environmental effects, but that may induce indirect and cumulative effects by permitting other development activities that have significant effects on air and water resources at a regional or national scale. The highway and the other development activities can reasonably be foreseen as "connected actions" (40 CFR § 1508.25).

Many times there is a mismatch between the scale at which environmental effects occur and the level at which decisions are made. Such mismatches present an obstacle to cumulative effects analysis. For example, while broad scale decisions are made at the program or policy level (e.g., National Energy Strategy, National Transportation Plan, Base Realignment and Closure Initiative), the environmental effects are generally assessed at the project level (e.g., coal-fired power plant, interstate highway connector, disposal of installation land). Cumulative effects analysis should be the tool for federal agencies to evaluate the implications of even project-level environmental assessments (EAs) on regional resources.

Federal agencies have struggled with preparing cumulative effects analyses since CEQ issued its regulations in 1978. They continue to find themselves in costly and time-consuming administrative proceedings and litigation over the proper scope of the analysis. Court cases throughout the years have affirmed CEQ's requirement to assess cumulative effects of projects but have added little in the way of guidance and direction. To date, there has not been a single, universally accepted conceptual approach, nor even general principles accepted by all scientists and managers. States and

other countries with "little NEPA" laws have experienced similar implementation problems.

A General Accounting Office (GAO) report on coastal pollution noted that state coastal managers raised concerns about the quality of cumulative effects analysis in environmental reviews for proposed federal activities (GAO 1991). In one case study, state coastal managers told GAO that the Environmental Impact Statement (EIS) for rerouting and expanding a highway did not consider that the project as proposed would have a significant growth-inducing effect that would exceed state planning limitations by 100 percent. The Department of Commerce acknowledged the need to provide additional guidance on how to assess the indirect and cumulative effects of proposed actions in the coastal zone and recently published a cumulative impacts assessment protocol for managing cumulative coastal environmental impacts (Vestal et al. 1995).

The increased use of EAs rather than EISs in recent years could exacerbate the cumulative effects problem. Agencies today prepare substantially more EAs than EISs; in a typical year 45,000 EAs are prepared compared to 450 EISs. An agency's decision to prepare an EIS is important because an EIS tends to contain more rigorous analysis and more public involvement than an EA. EAs tend to save time and money because an EA generally takes less time to prepare. They are a cost-effective way to determine whether potentially significant effects are likely and whether a project can mitigate these effects. At the same time, because EAs focus on whether effects are significant, they tend to underestimate the cumulative effects of their projects. Given that so many more EAs are prepared than EISs, adequate consideration of cumulative effects requires that EAs address them fully. One study analyzed 89 EAs announced in the *Federal Register* between January 1, 1992, and June 30, 1992, to determine the extent to which treatment of cumulative effects met CEQ's requirements (Figure 1-2). Only 35 EAs (39%) mentioned cumulative

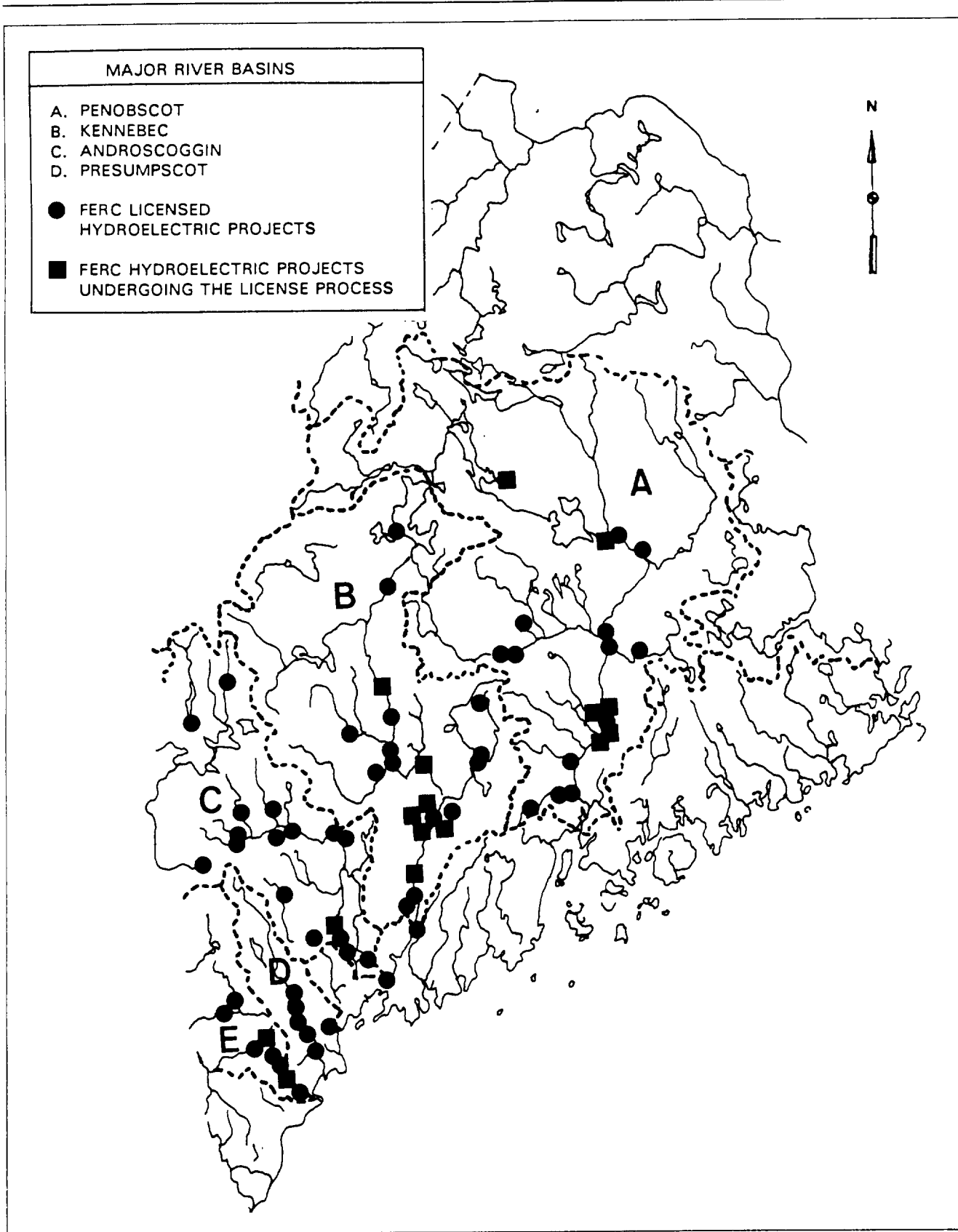
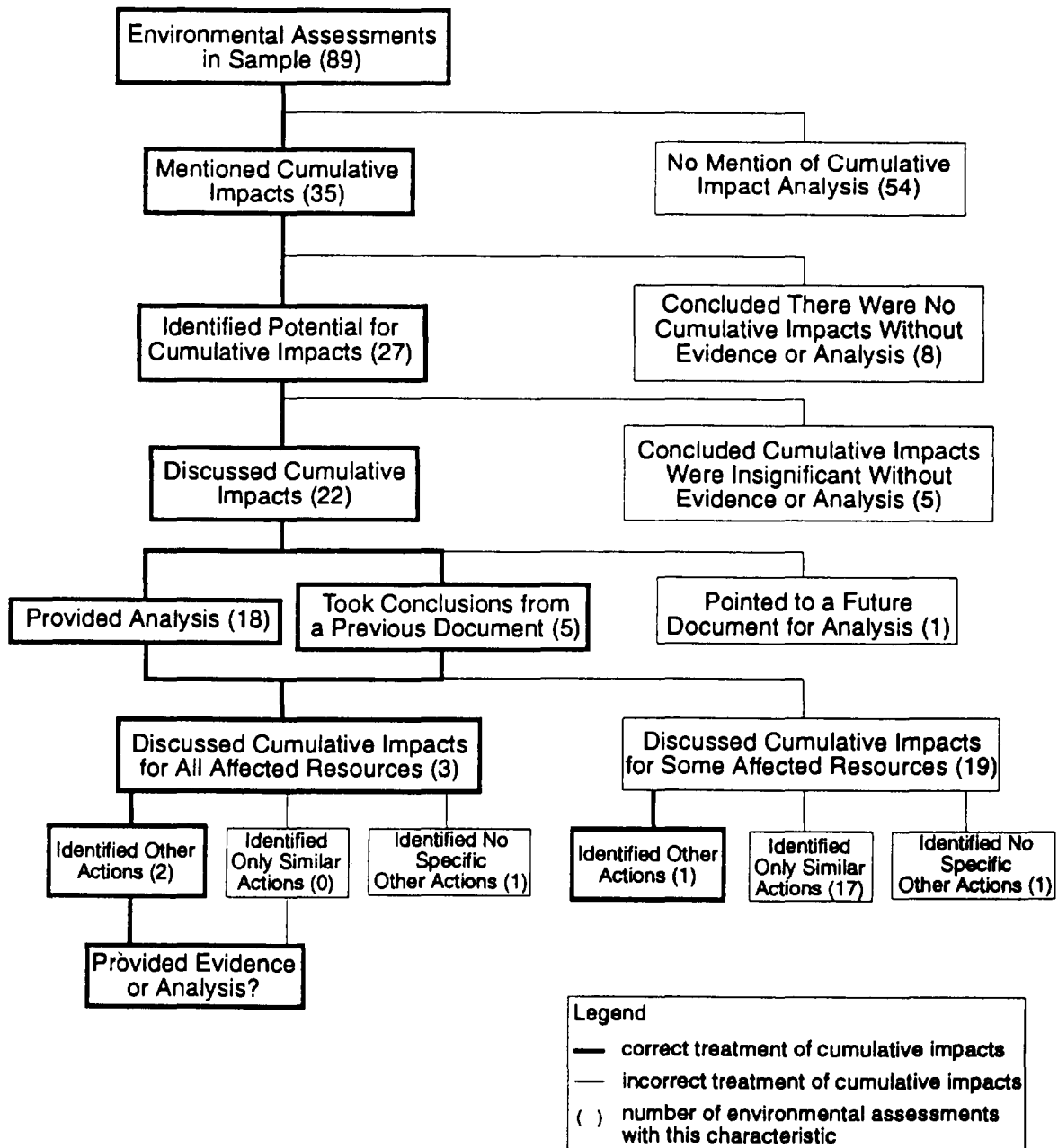

Figure 1-1. River basins and associated FERC related hydroelectric projects in Maine (undated)



For the 22 environmental assessments (EAs) that discussed cumulative impacts, the three treatments are not mutually exclusive. One EA in the sample provided analysis for some resources, took the conclusions from a previous document for one resource, and pointed to a future document for another resource. For this reason, the numbers in the boxes sum to 24 instead of 22.

Figure 1-2. Consideration of cumulative effects in environmental assessments (McCold and Holman 1995)

effects. Nearly half of those failed to present evidence to support their conclusions concerning cumulative effects (McCold and Holman 1995).

PRINCIPLES OF CUMULATIVE EFFECTS ANALYSIS

Increasingly, decisionmakers are recognizing the importance of looking at their projects in the context of other development in the community or region (i.e., of analyzing the cumulative effects). Direct effects continue to be most important to decisionmakers, in part because they are more certain. Nonetheless, the importance of acid rain, climate change, and other cumulative effects problems has resulted in many efforts to undertake and improve the analysis of cumulative effects. Although no universally accepted framework for cumulative effects analysis exists, general principles have gained acceptance (Table 1-2).

Each of these eight principles illustrates a property of cumulative effects analysis that differentiates it from traditional environmental impact assessment. By applying these principles to environmental analysis of all kinds, cumulative effects will be better considered, and the analysis will be complete. A critical principle states that cumulative effects analysis should be conducted within the context of resource, ecosystem, and human community thresholds—levels of stress beyond which the desired condition degrades. The magnitude and extent of the effect on a resource depends on whether the cumulative effects exceed the capacity of the resource to sustain itself and remain productive. Similarly, the natural ecosystem and the human community have maximum levels of cumulative effects that they can

withstand before the desired conditions of ecological functioning and human quality of life deteriorate.

Determining the threshold beyond which cumulative effects significantly degrade a resource, ecosystem, and human community is often problematic. Without a definitive threshold, the NEPA practitioner should compare the cumulative effects of multiple actions with appropriate national, regional, state, or community goals to determine whether the total effect is significant. These thresholds and desired conditions can best be defined by the cooperative efforts of agency officials, project proponents, environmental analysts, non-governmental organizations, and the public through the NEPA process. Ultimately, cumulative effects analysis under NEPA should be incorporated into the agency's overall environmental planning and the regional planning of other federal agencies and stakeholders.

HOW ENVIRONMENTAL EFFECTS ACCUMULATE

Cumulative effects result from spatial (geographic) and temporal (time) crowding of environmental perturbations. The effects of human activities will accumulate when a second perturbation occurs at a site before the ecosystem can fully rebound from the effect of the first perturbation. Many researchers have used observations or environmental change theory to categorize cumulative effects into different types. The diversity of sources, processes, and effects involved has prevented the research and assessment communities from agreeing on a standard typology. Nonetheless, it is useful to review the eight scenarios for accumulating effects shown in Table 1-3.

Table 1-2. Principles of cumulative effects analysis

1. Cumulative effects are caused by the aggregate of past, present, and reasonably foreseeable future actions.

The effects of a proposed action on a given resource, ecosystem, and human community include the present and future effects added to the effects that have taken place in the past. Such cumulative effects must also be added to effects (past, present, and future) caused by all other actions that affect the same resource.

2. Cumulative effects are the total effect, including both direct and indirect effects, on a given resource, ecosystem, and human community of all actions taken, no matter who (federal, nonfederal, or private) has taken the actions.

Individual effects from disparate activities may add up or interact to cause additional effects not apparent when looking at the individual effects one at a time. The additional effects contributed by actions unrelated to the proposed action must be included in the analysis of cumulative effects.

3. Cumulative effects need to be analyzed in terms of the specific resource, ecosystem, and human community being affected.

Environmental effects are often evaluated from the perspective of the proposed action. Analyzing cumulative effects requires focusing on the resource, ecosystem, and human community that may be affected and developing an adequate understanding of how the resources are susceptible to effects.

4. It is not practical to analyze the cumulative effects of an action on the universe; the list of environmental effects must focus on those that are truly meaningful.

For cumulative effects analysis to help the decisionmaker and inform interested parties, it must be limited through scoping to effects that can be evaluated meaningfully. The boundaries for evaluating cumulative effects should be expanded to the point at which the resource is no longer affected significantly or the effects are no longer of interest to affected parties.

5. Cumulative effects on a given resource, ecosystem, and human community are rarely aligned with political or administrative boundaries.

Resources typically are demarcated according to agency responsibilities, county lines, grazing allotments, or other administrative boundaries. Because natural and sociocultural resources are not usually so aligned, each political entity actually manages only a piece of the affected resource or ecosystem. Cumulative effects analysis on natural systems must use natural ecological boundaries and analysis of human communities must use actual sociocultural boundaries to ensure including all effects.

6. Cumulative effects may result from the accumulation of similar effects or the synergistic interaction of different effects.

Repeated actions may cause effects to build up through simple addition (more and more of the same type of effect), and the same or different actions may produce effects that interact to produce cumulative effects greater than the sum of the effects.

7. Cumulative effects may last for many years beyond the life of the action that caused the effects.

Some actions cause damage lasting far longer than the life of the action itself (e.g., acid mine drainage, radioactive waste contamination, species extinctions). Cumulative effects analysis needs to apply the best science and forecasting techniques to assess potential catastrophic consequences in the future.

8. Each affected resource, ecosystem, and human community must be analyzed in terms of its capacity to accommodate additional effects, based on its own time and space parameters.

Analysts tend to think in terms of how the resource, ecosystem, and human community will be modified given the action's development needs. The most effective cumulative effects analysis focuses on what is needed to ensure long-term productivity or sustainability of the resource.

Type	Main characteristics	Example
1. Time crowding	Frequent and repetitive effects on an environmental system	Forest harvesting rate exceeds regrowth
2. Time lags	Delayed effects	Exposure to carcinogens
3. Space crowding	High spatial density of effects on an environmental system	Pollution discharges into streams from nonpoint sources
4. Cross-boundary	Effects occur away from the source	Acidic precipitation
5. Fragmentation	Change in landscape pattern	Fragmentation of historic district
6. Compounding effects	Effects arising from multiple sources or pathways	Synergism among pesticides
7. Indirect effects	Secondary effects	Commercial development following highway construction
8. Triggers and thresholds	Fundamental changes in system behavior or structure	Global climate change

In simplest terms, cumulative effects may arise from single or multiple actions and may result in additive or interactive effects. Interactive effects may be either countervailing—where the net adverse cumulative effect is less than the sum of the individual effects—or

synergistic—where the net adverse cumulative effect is greater than the sum of the individual effects. This combination of two kinds of actions with two kinds of processes leads to four basic types of cumulative effects (Table 1-3; see Peterson et al. 1987 for a similar typology).

	Additive Process	Interactive Process
Single Action	<p>Type 1 — Repeated “additive” effects from a single proposed project.</p> <p>Example: Construction of a new road through a national park, resulting in continual draining of road salt onto nearby vegetation.</p>	<p>Type 2 — Stressors from a single source that interact with receiving biota to have an “interactive” (nonlinear) net effect.</p> <p>Example: Organic compounds, including PCBs, that biomagnify up food chains and exert disproportionate toxicity on raptors and large mammals.</p>
Multiple Actions	<p>Type 3 — Effects arising from multiple sources (projects, point sources, or general effects associated with development) that affect environmental resources additively.</p> <p>Example: Agricultural irrigation, domestic consumption, and industrial cooling activities that all contribute to drawing down a groundwater aquifer.</p>	<p>Type 4 — Effects arising from multiple sources that affect environmental resources in an interactive (i.e., countervailing or synergistic) fashion.</p> <p>Example: Discharges of nutrients and heated water to a river that combine to cause an algal bloom and subsequent loss of dissolved oxygen that is greater than the additive effects of each pollutant.</p>

ROADMAP TO THE HANDBOOK

The chapters that follow discuss the incorporation of cumulative effects analysis into the components of environmental impact assessment: scoping (Chapter 2), describing the affected environment (Chapter 3), and determining the environmental consequences (Chapter 4). Although cumulative effects analysis is an iterative process, basic steps that

to be accomplished can be identified in each component of the NEPA process; each chapter focuses on its constituent steps (Table 1-4). The last chapter of this report discusses developing a cumulative effects analysis methodology that draws upon existing methods, techniques, and tools to analyze cumulative effects. Appendix A provides brief descriptions of 11 cumulative effects analysis methods.

Table 1-5. Steps in cumulative effects analysis (CEA) to be addressed in each component of environmental impact assessment (EIA)	
EIA Components	CEA Steps
Scoping	<ol style="list-style-type: none"> 1. Identify the significant cumulative effects issues associated with the proposed action and define the assessment goals. 2. Establish the geographic scope for the analysis. 3. Establish the time frame for the analysis. 4. Identify other actions affecting the resources, ecosystems, and human communities of concern.
Describing the Affected Environment	<ol style="list-style-type: none"> 5. Characterize the resources, ecosystems, and human communities identified in scoping in terms of their response to change and capacity to withstand stresses. 6. Characterize the stresses affecting these resources, ecosystems, and human communities and their relation to regulatory thresholds. 7. Define a baseline condition for the resources, ecosystems, and human communities.
Determining the Environmental Consequences	<ol style="list-style-type: none"> 8. Identify the important cause-and-effect relationships between human activities and resources, ecosystems, and human communities. 9. Determine the magnitude and significance of cumulative effects. 10. Modify or add alternatives to avoid, minimize, or mitigate significant cumulative effects. 11. Monitor the cumulative effects of the selected alternative and adapt management.

2

SCOPING FOR CUMULATIVE EFFECTS

PRINCIPLES

- Include past, present, and future actions.
- Include all federal, nonfederal, and private actions.
- Focus on each affected resource, ecosystem, and human community.
- Focus on truly meaningful effects.

Expanding environmental impact assessment to incorporate cumulative effects can only be accomplished by the enlightened use of the scoping process. The purpose of scoping for cumulative effects is to determine (1) whether the resources, ecosystems, and human communities of concern have already been affected by past or present activities and (2) whether other agencies or the public have plans that may affect the resources in the future. This is best accomplished as an iterative process, one that goes beyond formal scoping meetings and consultations to include creative interactions with all the stakeholders. Scoping should be used in both the planning and project development stage (i.e., whenever information on cumulative effects will contribute to a better decision).

Scoping information may come from agency consultations, public comments, the analyst's own knowledge and experience, planning activities, the proponent's statements of purpose and need, underlying studies in support of the project proposal, expert opinion,

or other NEPA analyses. This information supports all the steps in cumulative effects analysis, including identifying data for establishing the environmental baseline (see Chapter 3) and identifying information related to impact significance (see Chapter 4). Most importantly, however, scoping for cumulative effects should include the following steps:

Step 1

Identify the significant cumulative effects issues associated with the proposed action and define the assessment goals.

Step 2

Establish the geographic scope for the analysis.

Step 3

Establish the time frame for the analysis.

Step 4

Identify other actions affecting the resources, ecosystems, and human communities of concern.

IDENTIFYING CUMULATIVE EFFECTS ISSUES

Identifying the major cumulative effects issues of a project involves defining the following:

- the direct and indirect effects of the proposed action,
- which resources, ecosystems, and human communities, are affected, and
- which effects on these resources are important from a cumulative effects perspective.

The proposed action may affect several resources either directly or indirectly. Resources can be elements of the physical environment, species, habitats, ecosystem parameters and functions, cultural resources, recreational opportunities, human community structure, traffic patterns, or other economic and social conditions. In a broad sense, all the impacts on affected resources are probably cumulative; however, the role of the analyst is to narrow the focus of the cumulative effects analysis to important issues of national, regional, or local significance. This narrowing can occur only after thorough scoping. The analyst should ask basic questions such as whether the proposed action will have effects similar to other actions in the area and whether the resources have been historically affected by cumulative actions (Table 2-1). Many significant cumulative effects issues are well known. Public interest groups, natural resource and land management agencies, and regulatory agencies regularly deal with cumulative effects. Newspapers and scientific journals frequently publish letters and comments dealing with these issues.

Not all potential cumulative effects issues identified during scoping need to be included in an EA or an EIS. Some may be irrelevant or inconsequential to decisions about the proposed action and alternatives. Cumulative effects analysis should "count what counts", not produce superficial analyses of a long laundry list of issues that have little relevance to the effects of the proposed action or the eventual decisions. Because cumulative effects can result from the activities of other agencies or persons, they may have already been analyzed by others and the importance of the issue determined. For instance, an agency proposing an action with minor effects on wetlands should not unilaterally decide that cumulative effects on wetlands is not an important issue. Cumulative effects analysis should consider the concerns of agencies managing and regulating wetlands,

as well as the regional history of cumulative wetland losses and degradation, and the presence of other proposals that would produce future wetland losses or degradation.

BOUNDING CUMULATIVE EFFECTS ANALYSIS

Once the study goals of the cumulative effects analysis are established, the analyst must decide on the specific content of the study that will meet those requirements. Analyzing cumulative effects differs from the traditional approach to environmental impact assessment because it requires the analyst to expand the geographic boundaries and extend the time frame to encompass additional effects on the resources, ecosystems, and human communities of concern.

Identifying Geographic Boundaries

For a project-specific analysis, it is often sufficient to analyze effects within the immediate area of the proposed action. When analyzing the contribution of this proposed action to cumulative effects, however, the geographic boundaries of the analysis almost always should be expanded. These expanded boundaries can be thought of as differences in hierarchy or scale. Project-specific analyses are usually conducted on the scale of counties, forest management units, or installation boundaries, whereas cumulative effects analysis should be conducted on the scale of human communities, landscapes, watersheds, or airsheds. Choosing the appropriate scale to use is critical and will depend on the resource or system. Figure 2-1 illustrates the utility of using the ecologically relevant watershed boundary of the Anacostia River basin rather than the political boundaries of local governments to develop restoration plans.

A useful concept in determining appropriate geographic boundaries for a cumulative effects analysis is the **project impact zone**.

Table 2-1. Identifying potential cumulative effects issues related to a proposed action

1. What is the value of the affected resource or ecosystem? Is it:
 - protected by legislation or planning goals?
 - ecologically important?
 - culturally important?
 - economically important?
 - important to the well-being of a human community?
2. Is the proposed action one of several similar past, present, or future actions in the same geographic area? (Regions may be land management units, watersheds, regulatory regions, states, ecoregions, etc.) *Examples: timber sales in a national forest; hydropower development on a river; incinerators in a community.*
3. Do other activities (whether governmental or private) in the region have environmental effects similar to those of the proposed action? *Example: release of oxidizing pollutants to a river by a municipality, an industry, or individual septic systems.*
4. Will the proposed action (in combination with other planned activities) affect any natural resources; cultural resources; social or economic units; or ecosystems of regional, national, or global public concern? *Examples: release of chlorofluorocarbons to the atmosphere; conversion of wetland habitat to farmland located in a migratory waterfowl flyway.*
5. Have any recent or ongoing NEPA analyses of similar actions or nearby actions identified important adverse or beneficial cumulative effect issues? *Examples: National Forest Plan EIS; Federal Energy Regulatory Commission Basinwide EIS or EA.*
6. Has the impact been historically significant, such that the importance of the resource is defined by past loss, past gain, or investments to restore resources? *Example: mudflat and salt-marsh habitats in San Francisco Bay.*
7. Might the proposed action involve any of the following cumulative effects issues?
 - long range transport of air pollutants resulting in ecosystem acidification or eutrophication
 - air emissions resulting in degradation of regional air quality
 - release of greenhouse gases resulting in climate modification
 - loading large water bodies with discharges of sediment, thermal, and toxic pollutants
 - reduction or contamination of groundwater supplies
 - changes in hydrological regimes of major rivers and estuaries
 - long-term containment and disposal of hazardous wastes
 - mobilization of persistent or bioaccumulated substances through the food chain
 - decreases in the quantity and quality of soils
 - loss of natural habitats or historic character through residential, commercial, and industrial development
 - social, economic, or cultural effects on low-income or minority communities resulting from ongoing development
 - habitat fragmentation from infrastructure construction or changes in land use
 - habitat degradation from grazing, timber harvesting, and other consumptive uses
 - disruption of migrating fish and wildlife populations
 - loss of biological diversity

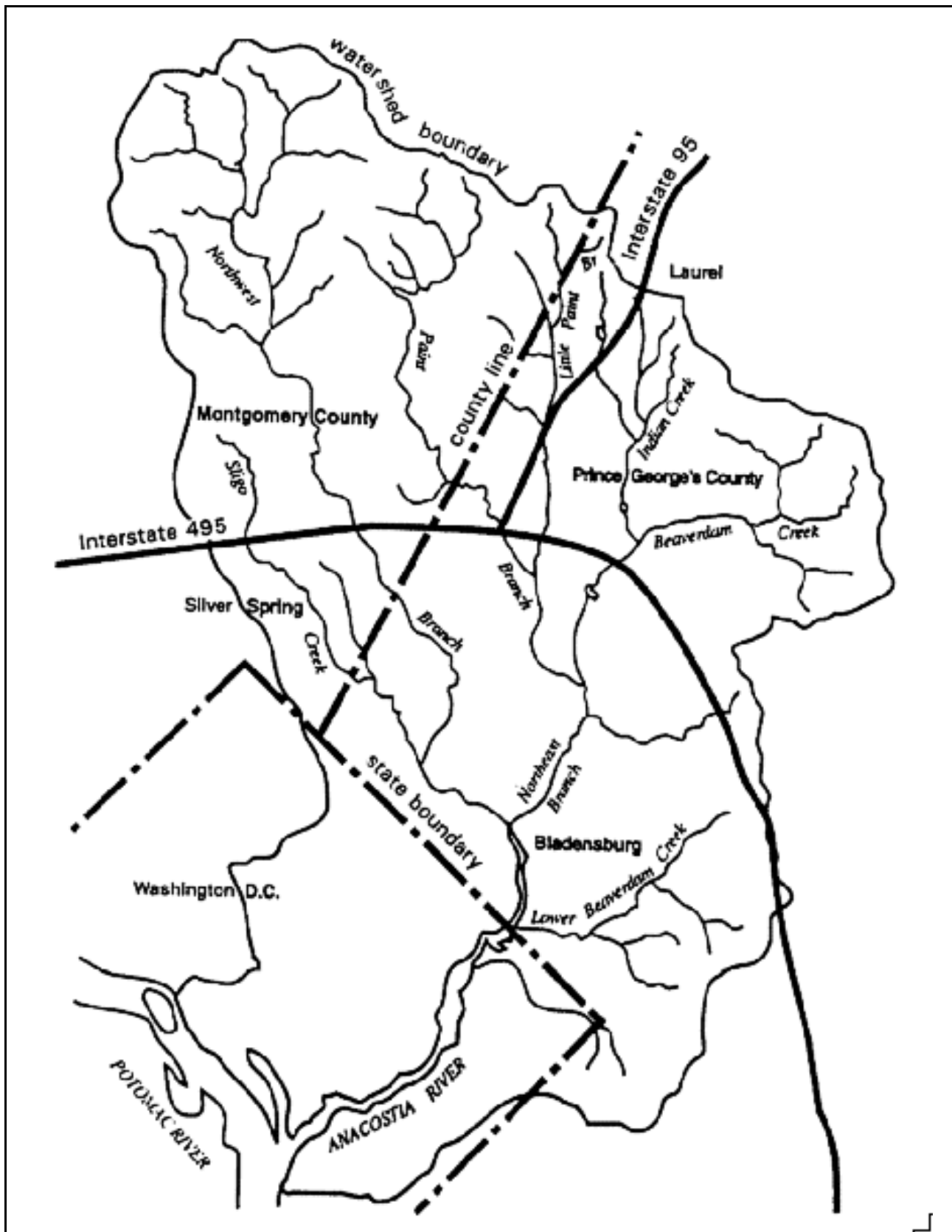

Figure 2-1. Juxtaposition of natural and political boundaries surrounding the Anacostia River

For a proposed action or reasonable alternative, the analysts should

- Determine the area that will be affected by that action. That area is the project impact zone.
- Make a list of the resources within that zone that could be affected by the proposed action.
- Determine the geographic areas occupied by those resources outside of the project impact zone. In most cases, the largest of these areas will be the appropriate area for the analysis of cumulative effects.
- Determine the affected institutional jurisdictions, both for the proposing agency and other agencies or groups.

Project impact zones for a proposed action are likely to vary for different resources and environmental media. For water, the project impact zone would be limited to the hydrologic system that would be affected by the proposed action. For air, the zone may be the physiographic basin in which the proposed action would be located. Land-based effects may occur within some set distance from the proposed action. In addition, the boundaries for an individual resource should be related to the resource's dependence on different environmental media. Table 2-2 provides some possible geographic boundaries for different resources. This list is *not* inclusive. The applicable geographic scope needs to be defined case by case.

Table 2-2. Geographic areas that could be used in a cumulative effects analysis	
Resource	Possible Geographic Areas for Analysis
Air quality	Metropolitan area, airshed, or global atmosphere
Water quality	Stream, watershed, river basin, estuary, aquifer, or parts thereof
Vegetative resources	Watershed, forest, range, or ecosystem
Resident wildlife	Species habitat or ecosystem
Migratory wildlife	Breeding grounds, migration route, wintering areas, or total range of affected population units
Fishery resources	Stream, river basin, estuary, or parts thereof; spawning area and migration route
Historic resources	Neighborhood, rural community, city, state, tribal territory, known or possible historic district
Sociocultural resources	Neighborhood, community, distribution of low-income or minority population, or culturally valued landscape
Land use	Community, metropolitan area, county, state, or region
Coastal zone	Coastal region or watershed
Recreation	River, lake, geographic area, or land management unit
Socioeconomics	Community, metropolitan area, county, state, or country

One way to evaluate geographic boundaries is to consider the distance an effect can travel. For instance, air emissions can travel substantial distances and are an important part of regional air quality. Air quality regions are defined by the EPA, and these regions are an appropriate boundary for assessment of the cumulative effects of releases of pollutants to the atmosphere. For water resources, an appropriate regional boundary may be a river basin or parts thereof. Watershed boundaries are useful for cumulative effects analysis because (1) pollutants and material released in the watershed may travel downstream to be mingled with other pollutants and materials; (2) migratory fish may travel up and down the river system during their life cycle; and (3) resource agencies may have basin-wide management and planning goals. For land-based effects, an appropriate regional boundary may be a "forest or range," a watershed, an ecological region (ecoregion), or socioeconomic region (for evaluating effects on human communities). Which boundary is the most appropriate depends both on the accumulation characteristics of the effects being assessed and an evaluation of the management or regulatory interests of the agencies involved.

Identifying Time Frames

The time frame of the project-specific analysis should also be evaluated to determine its applicability to the cumulative effects analysis. This aspect of the cumulative effects analysis may at first seem the most troublesome to define. CEQ's regulations define cumulative effects as the "incremental effect of the action when added to other past, present, and reasonably foreseeable future actions" (40 CFR § 1508.7). In determining how far into the future to analyze cumulative effects, the analyst should first consider the time frame of the project-specific analysis. If the effects of the proposed action are projected to last five years, this time frame may be the most appropriate for

the cumulative effects analysis. The analyst should attempt to identify actions that could reasonably be expected to occur within that period.

There may be instances when the time frame of the project-specific analysis will need to be expanded to encompass cumulative effects occurring further into the future (Figure 2-2). For instance, even though the effects of a proposed action may linger or decrease slowly through time, the time frame for the project-specific analysis usually does not extend beyond the time when project-specific effects drop below a level determined to be significant. These project-specific effects, however, may combine with the effects of other actions beyond the time frame of the proposed action and result in significant cumulative effects that must be considered.

IDENTIFYING PAST, PRESENT, AND REASONABLY FORESEEABLE FUTURE ACTIONS

As described above, identifying past, present, and future actions is critical to establishing the appropriate geographic and time boundaries for the cumulative effects analysis. Identifying boundaries and actions should be iterative within the scoping process.

A schematic diagram showing the area in which the proposed action is located, the location of resources, and the location of other facilities (existing or planned), human communities, and disturbed areas can be useful for identifying actions to be included in the cumulative effects analysis (Figure 2-3). A geographic information system (GIS) or a manual map overlay system can be used to depict this information (see Appendix A for a description of map overlays and GIS). Such a diagram is useful for determining project-specific impact zones and their overlap with areas affected by other nonproject actions.

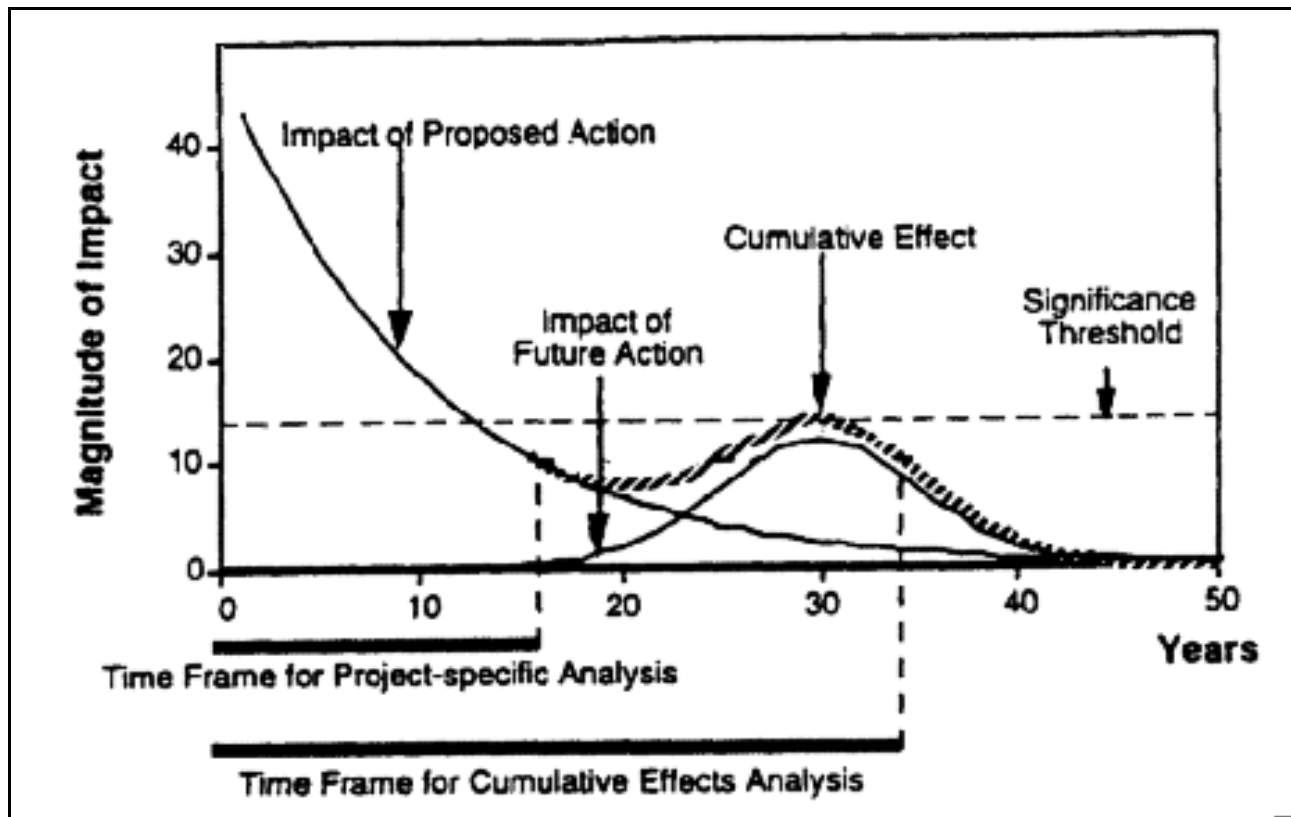

Figure 2-2. Time frames for project-specific and cumulative effects analyses

By examining the overlap of impact zones on the areas occupied by resources, it should be possible to refine the list of projects or activities (past, present, or future) to be included in the analysis. Proximity of actions may not be sufficient justification to include them in the analysis. In the example shown in Figure 2-3, the cumulative effects analysis for trout should consider the effects of the existing mine and the planned logging activity, because these activities would have either present or future effects on the trout spawning area below the proposed power plant facility. Although an agricultural area is nearby, it can be excluded from the analysis because its sediment loading effects occur downstream of the trout spawning area. Proximity of other actions to the proposed action is not the decisive factor for including these actions in an analysis; these actions must have some influence on the resources affected by the proposed action. In other words, these other actions should be included in analysis when

their impact zones overlap areas occupied by resources affected by the proposed action.

Completing the geographic or schematic diagram depending on applying cause-and-effect models that link human actions and the resources or ecosystems. This too is an iterative process. Identifying other activities contributing to cumulative effects could result in the addition of new effect pathways to the cause-and-effect model. In the example, addition of an existing mine to the cumulative effects analysis could require adding a pathway for the effects of chemical pollution on trout. Chapters 4 and 5 and Appendix A discuss cause-and-effect modeling and network analysis.

The availability of data often determines how far back past effects are examined. Although certain types of data (e.g., forest cover) may be available for extensive periods in the past (i.e., several decades), other data (e.g., water quality data) may be available only for

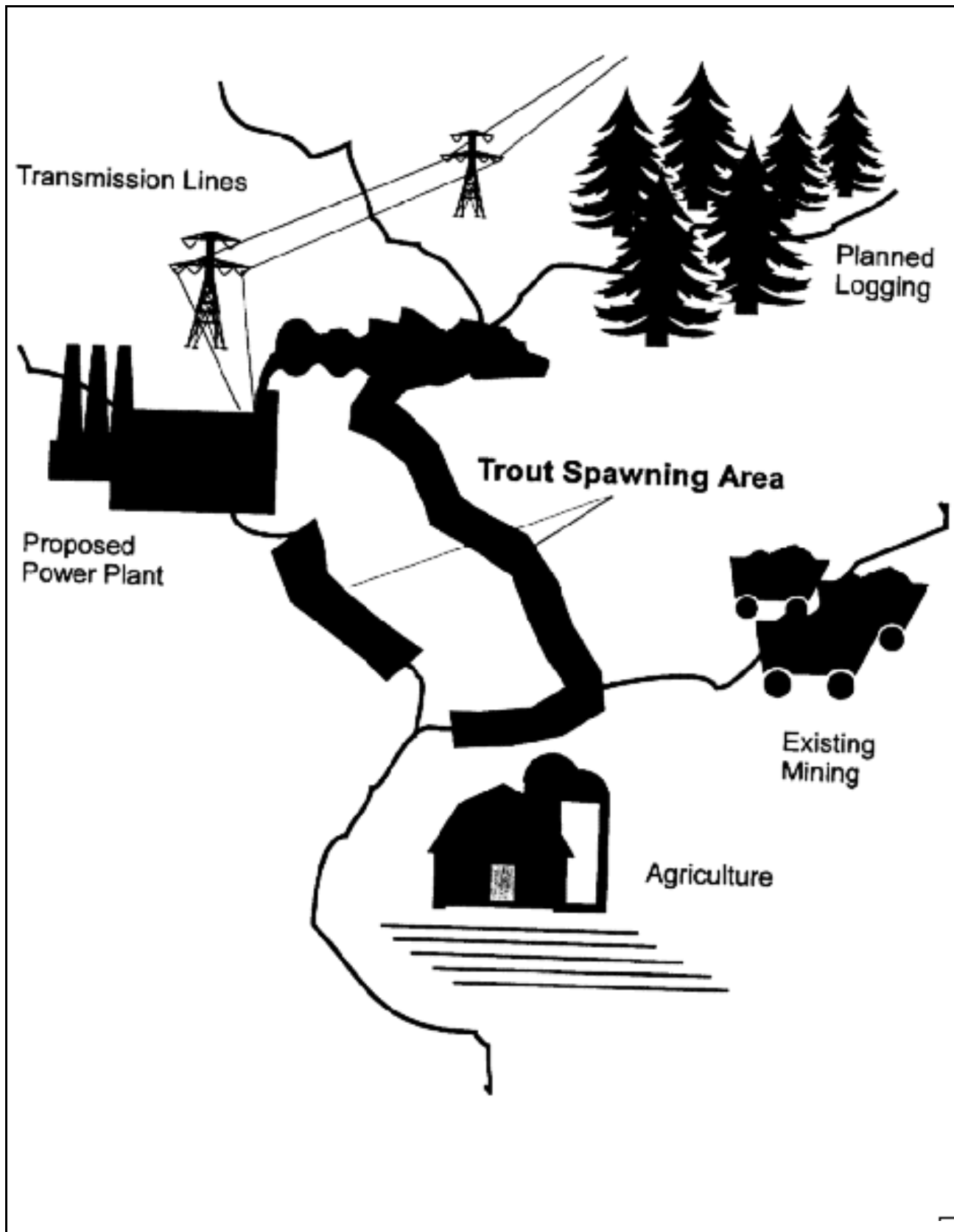

Figure 2-3. Impact zones of proposed and existing development relative to a trout population

much shorter periods. Because the data describing past conditions are usually scarce, the analysis of past effects is often qualitative.

Identifying similar actions presently underway is easier than identifying past or future actions, but it is by no means simple. Because most of the analytical effort in an environmental impact assessment deals with the proposed action, the actions of other agencies and private parties are usually less well known. Effective cumulative effects analysis requires close coordination among agencies to ensure that even all present actions, much less past and future actions, are considered.

The first step in identifying future actions is to investigate the plans of the proponent agency and other agencies in the area. Commonly, analysts only include those plans for actions which are funded or for which other NEPA analysis is being prepared. This approach does not meet the letter or intent of CEQ's regulations. It underestimates the number of future projects, because many viable actions may be in the early planning stage. On the other hand, some actions in the planning, budgeting, or execution phase may not go forward. To include all proposals ever considered as other actions would most likely overestimate the future effects of cumulative effects on the resources, ecosystems, and human communities; therefore, the analyst should develop guidelines as to what constitutes "reasonably foreseeable future actions" based on the planning process within each agency. Specifically, the analyst should use the best available information to develop scenarios that predict which future actions might reasonably be expected as a result of the proposal. Such scenarios are generally based on experience obtained from similar projects located elsewhere in the region. Including future actions in the study is much easier if an agency has already developed a planning document that identifies proposed future actions and has communicated these plans to other federal agencies and governmental bodies in the affected region.

When identifying future actions to include in the cumulative effects analysis, reasonably

foreseeable actions by private organizations or individuals are usually more difficult to identify than those of federal or other governmental entities. In many cases, local government planning agencies can provide useful information on the likely future development of the region, such as master plans. Local zoning requirements, water supply plans, economic development plans, and various permitting records will help in identifying reasonably foreseeable private actions (see Chapter 3 for other sources of information). In addition, some private landowners or organizations may be willing to share their plans for future development or land use. These plans can be considered in the analysis, but it is important to indicate in the NEPA analysis whether these plans were presented by the private party responsible for originating the action. Whenever speculative projections of future development are used, the analyst should provide an explicit description of the assumptions involved. If the analyst is uncertain whether to include future actions, it may be appropriate to bound the problem by developing several scenarios with different assumptions about future actions.

In general, future actions can be excluded from the analysis of cumulative effects if

- the action is outside the geographic boundaries or time frame established for the cumulative effects analysis;
- the action will not affect resources that are the subject of the cumulative effects analysis; or
- including of the action would be arbitrary.

At the same time, NEPA litigation [*Scientists' Institute for Public Information, Inc., v. Atomic Energy Commission* (481 F.2d 1079 D.C. Cir.1073)] has made it clear that "reasonable forecasting" is implicit in NEPA and that it is the responsibility of federal agencies to predict the environmental effects of proposed actions before they are fully known. CEQ's regulations provide for including these uncertainties in the environmental impact assessment where the

foreseeable future action is not planned in sufficient detail to permit complete analysis. Specifically, CEQ's regulations state

[w]hen an agency is evaluating reasonably foreseeable significant adverse effects on the human environment in an environmental impact statement and there is incomplete or unavailable information, ... [that] cannot be obtained because the overall costs of obtaining it are exorbitant or the means to obtain it are not known,... the agency shall include... the agency's evaluation of such impacts based upon theoretical approaches or research methods generally accepted in the scientific community (40 CFR § 1502.22).

Even when the decisionmaker does not select the environmentally preferable alternative, including the cumulative effects of future actions in the analysis serves the important NEPA function of informing the public and potentially influencing future decisions.

AGENCY COORDINATION

Because the actions of other agencies are part of cumulative effects analysis, greater emphasis should be placed on consulting with other agencies than is commonly practiced. Fortunately, when federal agencies adopt the ecosystem approach to management (espoused by the Interagency Ecosystem Management Task Force) such consultation probably will be enhanced (see box). During scoping, periodic coordination with other agencies may enhance the cumulative effects analysis process. As described above, a cumulative effects analysis might

- include an assessment of another agency's proposed action,
- include an assessment of the effects of another agency's completed actions,
- evaluate another agency's resource management practices and goals, or

- evaluate another agency's future plans.

Ecosystem Management

Vice President Gore's National Performance Review called for the agencies of the federal government to adopt "a proactive approach to ensuring a sustainable economy and a sustainable environment through ecosystem management." The Interagency Ecosystem Management Task Force (IEMTF 1995) was established to carry out this mandate. The ecosystem approach espoused by IEMTF and a wide range of government, industry, and private interest groups is a method for sustaining or restoring natural systems in the face of the cumulative effects of many human actions. In addition to using the best science, the ecosystem approach to management is based on a collaboratively developed vision of desired future conditions that integrates ecological, economic, and social factors. Achieving this shared vision requires developing partnerships with nonfederal stakeholders and improving communication between federal agencies and the public. Many ecosystem management initiatives are underway across the United States. The lessons learned from these experiences should be incorporated into the scoping process under NEPA to address cumulative effects more effectively. The IEMTF specifically recommends that agencies develop regional ecosystem plans to coordinate their review activities under NEPA. These ecosystem plans can provide a framework for evaluating the environmental status quo and the combined cumulative effects of individual projects.

The success of any of these activities is enhanced by coordination with the affected agency. At a minimum, the analyst should establish an ongoing process of periodic consultation and coordination with other agencies early in the scoping process whenever there are significant cumulative effects issues. Where appropriate, the lead agency should pursue cooperating agency status for affected agencies to facilitate reviewing drafts, supplying information, writing sections of the document, and using the

document to support more than one agency's programs.

SCOPING SUMMARY

Scoping for cumulative effects analysis is a proactive and iterative process. It involves a thorough evaluation of the proposed action and its environmental context. During the scoping process, the analyst should

- consult with agencies and other interested persons concerning cumulative effects issues;
- evaluate the agency's planning as well as the proposed action and reasonable alternatives (including the no-action alternative) to identify potential cumulative effects;
- evaluate the importance of the cumulative effects issues associated with a proposed action to identify additional resources, ecosystems, and human communities that should be included in the EA or EIS;
- identify the geographic boundaries for analysis of the cumulative effects on each resource, ecosystem, and human community;

- identify a time frame for the analysis of the cumulative effects on each resource, ecosystem, and human community; and
- determine which other actions should be included in the analysis and agree among interested parties on the scope of the data to be gathered, the methods to be used, the way the process will be documented, and how the results will be reviewed.

At the end of the scoping process, there should be a list of cumulative effects issues to be assessed, a geographic boundary and time frame assigned for each resource analysis, and a list of other actions contributing to each cumulative effects issue. In addition, during scoping the analyst should obtain information and identify data needs related to the affected environment (Chapter 3) and environmental consequences (Chapter 4) of cumulative effects, including resource capabilities, thresholds, standards, guidelines, and planning goals.

3

DESCRIBING THE AFFECTED ENVIRONMENT

PRINCIPLES

- Use natural boundaries.
- Focus on each affected resource, ecosystem, and human community.

Characterizing the affected environment in a NEPA analysis that addresses cumulative effects requires special attention to defining baseline conditions. These baseline conditions provide the context for evaluating environmental consequences and should include historical cumulative effects to the extent feasible. The description of the affected environment relies heavily on information obtained through the scoping process (Chapter 2) and should include all potentially affected resources, ecosystems, and human communities. Determining the cumulative environmental consequences based on the baseline conditions will be discussed in Chapter 4. The affected environment section serves as a "bridge" between the identification during scoping of cumulative effects that are likely to be important and the analysis of the magnitude and significance of these cumulative effects. Specifically, describing the environment potentially affected by

cumulative effects should include the following steps:

Step 5

Characterize the resources, ecosystems, and human communities identified during scoping in terms of their response to change and capacity to withstand stresses.

Step 6

Characterize the stresses affecting these resources, ecosystems, and human communities and their relation to regulatory thresholds.

Step 7

Define a baseline condition for the resources, ecosystems, and human communities.

Describing the affected environment when considering cumulative effects does not differ greatly from describing the affected environment as part of project-specific analyses; however, analyses and supporting data should be extended in terms of geography, time, and the potential for resource or system interactions. In project-specific NEPA analysis, the description of the affected environment is based on a list of resources that may be directly or indirectly affected by the proposed project. In cumulative effects analysis, the analyst must attempt to identify and characterize effects of other actions on these same resources. The affected environment for a cumulative effects analysis,

therefore, may require wider geographic boundaries and a broader time frame to consider these actions (see the discussion on bounding cumulative effects analysis in Chapter 2).

COMPONENTS OF THE AFFECTED ENVIRONMENT

To address cumulative effects adequately, the description of the affected environment should contain four types of information:

- data on the **status** of important natural, cultural, social, or economic **resources and systems**;
- data that characterize important environmental or social **stress factors**;
- a description of pertinent **regulations, administrative standards, and development plans**; and
- data on environmental and socioeconomic **trends**.

The analyst should begin by evaluating the existing resources likely to be cumulatively affected, including one or more of the following: soils, geology and geomorphology, climate and rainfall, vegetative cover, fish and wildlife water quality and quantity, recreational uses, cultural resources, and human community structure within the area of expected project effects. The analyst should also review social and economic data (including past and present land uses) closely associated with the status of the resources, ecosystems, and human communities of concern. The description of the affected environment should focus on how the existing conditions of key resources, ecosystems, and human communities have been altered by human activities. This historical context should include important human stress factors and pertinent environmental regulations and standards. Where possible, trends in the condition of resources, ecosystems, and human communities should be identified. The

description of the affected environment will not only provide the baseline needed to evaluate environmental consequences, but also it will help identify other actions contributing to cumulative effects. While describing the affected environment, the analyst should pay special attention to common natural resource and socioeconomic issues that arise as a result of cumulative effects. The following list describes many issues but is by no means exhaustive:

Air

- Human health hazards and poor visibility from the cumulative effects of emissions that lower ambient air quality by elevating levels of ozone, particulates, and other pollutants.
- Regional and global atmospheric alterations from cumulative additions of pollutants that contribute to global warming, acidic precipitation, and reduced ultraviolet radiation absorption following stratospheric ozone depletion.

Surface Water

- Water quality degradation from multiple point-source discharges.
- Water quality degradation from land uses that result in nonpoint-source pollution within the watershed.
- Sediment delivery to a stream or estuary from multiple sources of soil erosion caused by road construction, forestry practices, and agriculture.
- Water shortages from unmanaged or unmonitored allocations of the water supply that exceed the capacity of the resource.
- Deterioration of recreational uses from nonpoint-source pollution, competing uses for the water body, and overcrowding.

Ground Water

- Water quality degradation from nonpoint- and multiple-point sources of pollution that infiltrate aquifers.
- Aquifer depletion or salt water intrusion following the overdraught of ground-water for numerous uncoordinated uses.

Lands and Soils

- Diminished land fertility and productivity through chemical leaching and salinization resulting from nonsustainable agricultural practices.
- Soil loss from multiple, uncoordinated activities such as agriculture on excessive gradients, overharvesting in forestry, and highway construction.

Wetlands

- Habitat loss and diminished flood control capacity resulting from dredging and filling individual tracts of wetlands.
- Toxic sediment contamination and reduced wetlands functioning resulting from irrigation and urban runoff.

Ecological Systems

- Habitat fragmentation from the cumulative effects of multiple land clearing activities, including logging, agriculture, and urban development.
- Degradation of sensitive ecosystems (e.g., old growth forests) from incremental stresses of resource extraction, recreation, and second-home development.
- Loss of fish and wildlife populations from the creation of multiple barriers to migration (e.g., dams and highways).

Historic and Archaeological Resources

- Cultural site degradation resulting from streambank erosion, construction, plowing and land leveling, and vandalism.

- Fragmentation of historic districts as a result of uncoordinated development and poor zoning.

Socioeconomics

- Over-burdened social services due to sudden, unplanned population changes as a secondary effect of multiple projects and activities.
- Unstable labor markets resulting from changes in the pool of eligible workers during "boom" and "bust" phases of development.

Human Community Structure

- Disruption of community mobility and access as a result of infrastructure development.
- Change in community dynamics by incremental displacement of critical community members as part of unplanned commercial development projects.
- Loss of neighborhoods or community character, particularly those valued by low-income and minority populations, through incremental development.

The cumulative effects analyst should determine if the resources, ecosystems, and human communities identified during scoping include all that could potentially be affected when cumulative effects are considered. This means reviewing the list of selected resources in terms of their expanded geographic boundaries and time frames. It also requires evaluating the system interactions that may identify additional resources subject to potential cumulative effects. If scoping addresses a limited set of resources and fails to consider those with which they interact, the analyst should evaluate the need to consider additional resources. The analyst should return to the list of resources frequently and be willing to modify it as necessary; furthermore, the analyst should be able to identify and discuss conflicts between

the resources (such as competition for regulated instream flows between fishery interests and the whitewater boating community).

Status of Resources, Ecosystems, and Human Communities

Determining the status of the affected environment depends on obtaining data about the resources, ecosystems, and human communities of concern. The availability of information continues to vary, but the number of useful indicators of ecological condition has increased greatly in recent years. In particular, indicators of the health or integrity of biological communities are in widespread use by water resource management agencies (Southerland and Stribling 1995). The concept of "indices of biotic integrity" (Karr et al. 1986; Karr 1991) is a powerful tool for evaluating the cumulative effects on natural systems, because biological communities act as integrators of multiple stresses over time. By using biological indicators in conjunction with reference or minimally affected sites, investigators have described the baseline conditions of entire regions. This approach has been applied to many freshwater and estuarine environments. Figure 3-1 describes the status of benthic communities of estuarine organisms in the Chesapeake Bay (Ranasinghe et al. 1994). This kind of information can be used to describe the baseline conditions at both the site and regional scales.

A second major innovation in indicators of resource or ecosystem condition is the development of landscape metrics. The discipline of landscape ecology recognizes that critical ecological processes such as habitat fragmentation require a set of indicators (e.g., habitat pattern shape, dominance, connectivity, configuration) at the landscape scale (Forman and Godron 1986; Risser et al. 1984). Investigators at the Oak Ridge National Laboratory and elsewhere have developed several indicators that can be used in conjunction with remote sensing and GIS technologies to describe the environmental baseline for sites or regions (O'Neill et al. 1988, 1994). The comprehensive spatial coverage and

multiple characterizations over time available from remote sensing make linking these measures to known environmental conditions one of the most promising approaches for assessing status and trends in resources and ecosystems.

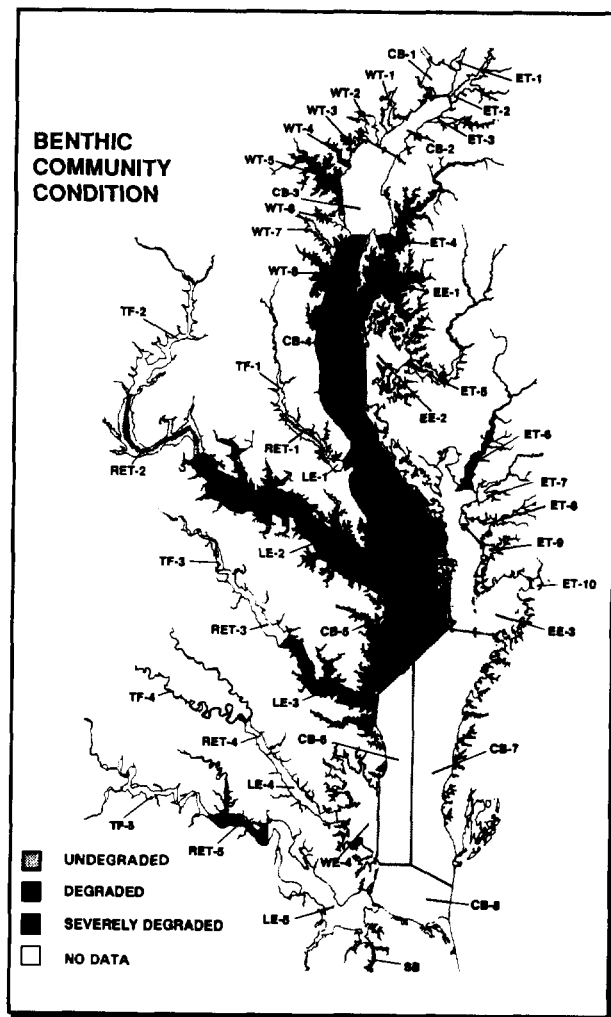

Figure 3-1. Status of benthic communities as a baseline of ecological conditions in the Chesapeake Bay (Ranasinghe et al. 1994)

Indicators have also been developed to gauge the well-being of human communities. Concern about human health and environmental conditions in minority and low-income communities has resulted in directives and guidelines for addressing environmental justice (see box). The structure, or societal setting, of human communities is analogous to the

structure of a natural ecosystem. Human communities are integrated entities with characteristic compositions, structures, and functioning. The community profile draws upon indicators of these aspects to describe the integrity of the community (FHWA 1996). Community indicators can range from general variables such as "social service provision" to specific indicators such as "distance to nearest hospital." Indicators can also be composites of different factors. For example, the familiar "quality of life" indicator is an attempt to merge key economic,

cultural, and environmental factors into an overall characterization of community well-being.

Characterization of Stress Factors

Environmental impact assessment is an attempt to characterize the relationship between human activities and the resultant environmental and social effects; therefore, the next step in describing the affected environment is to compile data on stress factors pertaining to each resource, ecosystem, and human community. Table 3-1 lists 26 activities (both existing and proposed), in addition to the proposed action, that may cumulatively affect resources of concern for the Castle Mountain Mining Project (U.S. BLM 1990). For each activity in this example, anticipated cumulative effects are identified for each of 12 resource issues. The primary locations of expected effects are also listed. The analyst should use this kind of stress information to summarize the overall adverse effect on the environment. Analogously, other activities that benefit the environment (e.g., restoration projects) should be included to determine the overall net (adverse or beneficial) effect on the environment. Where activities contributing to cumulative effects are less well defined, a general stress level can be described. For instance, the affected environment discussion need not address every farm in the watershed, but it should note the presence of substantial agricultural activity.

Environmental Justice

In 1994, President Clinton issued Executive Order 12898, "Federal Actions to Address Environmental Justice in Minority Populations and Low-Income Populations," requiring federal agencies to adopt strategies to address environmental justice concerns within the context of agency operations. In an accompanying memorandum, the President emphasizes that existing laws, including NEPA, provide opportunities for federal agencies to address this issue. The U.S. EPA has stated that addressing environmental justice concerns is entirely consistent with NEPA and that disproportionately high and adverse human health or environmental effects on minority or low-income populations should be analyzed with the same tools currently intrinsic to the NEPA process. Specifically, the analysis should focus on smaller areas or communities within the affected area to identify significant effects that may otherwise have been diluted by an examination of a larger population or area. Demographic, geographic, economic, and human health and risk factors all contribute to whether the populations of concern face disproportionately high and adverse effects. Public involvement is particularly important for identifying the aspects of minority and low-income communities that need to be addressed. Early and sustained communications with the affected community throughout the NEPA process is an essential aspect of environmental justice.

Two types of information should be used to describe stress factors contributing to cumulative effects. First, the analyst should identify the types, distribution, and intensity of key social and economic activities within the region. Data on these socioeconomic "driving variables" can identify cumulative effects problems in the project area (McCabe et al. 1991). For example, population growth is strongly associated with habitat loss. A federal proposal that would contribute to substantial population growth in a specific region (e.g., a highway project traversing a remote area) should be viewed as a likely driving variable for environmental effects.

Table 3-1. Other activities (existing and proposed) that may cumulatively affect resources of concern for the Castle Mountain Mining Project (U.S. BLM 1990)

Description/Responsible Agency	Status	Anticipated Environmental Issues That Could Be Cumulative	Primary Impact Location
Utilities/Services			
1 AT&T Communication cable upgrading (BLMN)	E,P	4,1	IV
2 PacBell microwave sites (BLMN)	E,P	4,1	IV
3 Bio Gen power plant (SBC)	E	2	IV
4 Additional utility lines (1-15 corridor) (BLMN)	P	4,4	IV
5 Whiskey Pete's airstrip/waterline (BLMN)	P	4	IV
6 Solid waste landfill (UP Tracks near state line) (BLMN)	P	4,12	IV
7 Waste water ponds (Ivanpah Lake) (BLMN)	E	4,9	IV
8 Nipton waste site (BLMN)	P	4,9	IV
9 LA-Las Vegas bullet train (BLMN)	P	4,9,10	IV
Commercial and Residential			
10 Nipton land exchange (BLMN)	P	4,6,12	IV
11 Scattered residential units (BLMN)	E,P	--	LV
Recreation			
12 Ivanpah Lake landsailing (BLMN)	E	4,5,10	IV
13 Barstow to Vegas ORV race (BLMN)	E	4,5,10	IV
14 East Mojave Heritage Trail use (BLMN)	E	4,5,10	IV,LV,PV
15 Mojave Road use (BLMN)	E	4,5,10	IV,LV,PV
16 Clark Country Road A68P use (BLMS,CC)	E	4,5,10	PV
Mining			
17 Proposed Action/Alternative - precious metals (BLMN)	P	3,4,5,8,9	LV
18 Colosseum Mine - precious metals (BLMN)	E	3,4,5,8,9	IV
19 Caltrans borrow pits - aggregates (BLMN)	E	4,5	IV
20 Morning Star Mine - precious metals (BLMN)	E	3,4,5,8,9	IV
21 Vanderbilt - precious metals mill site (BLMN)	E	3,4,5,8,9	IV
22 Golden Quail Mine - precious metals (BLMN)	E	3,4,5,8,9	LV
23 Hart District Clay Pits (BLMN)	E	4,9	LV
24 Mountain Pass Mine - rare earth materials (BLMN)	E	3,4,5,8,9	IV
25 Exploratory activities (BLMN, BLMS)	E,P	4,5,9	LV,PV
Grazing			
26 Grazing leases (BLMN, BLMS)	E	4,5	IV,V,PV
Source of Information BLMN: BLM Needles BLMS: BLM Stateline SBC: San Bernardino County, Planning Department CC: Clark County, Planning Department	Status E: Existing P: Proposed	Issues 1 Earth 2 Air 3 Water 4 Wildlife 5 Vegetation 6 Transportation 7 Public Service/Utilities 8 Health/Safety 9 Visual Resources 10 Recreation 11 Cultural Resources 12 Land Use	Location PV: Piute Valley IV: Ivanpah Valley LV: Lanfair Valley

Second, the analyst should look for individual indicators of stress on specific resources, ecosystems, and human communities. Like the familiar "canary in the coal mine," changes in certain resources can serve as an early warning of impending environmental or social degradation (Reid et al. 1991). Indicators of environmental stress can be either exposure-oriented (e.g., contamination levels) or effects-oriented (e.g., loss or degradation of a fishery). High sediment loads and the loss of stable stream banks are both common indicators of cumulative effects from urbanization.

The goal of characterizing stresses is to determine whether the resources, ecosystems, and human communities of concern are approaching conditions where additional stresses will have an important cumulative effect. Simple maps (Figure 3-2) of existing and planned activities can indicate likely cumulative effects, as in the example of Seattle's Southwest Harbor (USACE et al. 1994). Regulatory, administrative, and planning information can also help define the condition of the region and the development pressures occurring within it. Lastly, trends analysis of change in the extent and magnitude of stresses is critical for projecting the future cumulative effect.

Regulations, Administrative Standards, and Regional Plans

Government regulations and administrative standards (e.g., air and water quality criteria) can play an important role in characterizing the regional landscape. They often influence developmental activity and the resultant cumulative stress on resources, ecosystems, and human communities. They also shape the manner in which a project may be operated, the amount of air or water emissions that can be released, and the limits on resource harvesting or extraction. For example, designation of a "Class I" air quality area can restrict some types of development in a region because the Prevention of Significant Deterioration (PSD) requirement establishes a threshold of cumulative air quality degradation.

In the United States, agencies at many different levels of government share responsibilities for resource use and environmental protection. In general, the federal government is charged with functions such as national standard-setting, whereas state governments manage implementation by issuing permits and monitoring compliance with regulatory standards. Each of the states handles environmental regulation and resource management in its own way. Most states have chartered specific agencies for environmental protection, resource management, or both. This information, along with contact names, can be obtained from the Council of State Governments (Brown and Marshall 1993). States usually have discretion under federal law to set standards more stringent than national ones. Land-use decisions are usually made by local governments. Local control may take the form of authority to adopt comprehensive land use plans; to enact zoning ordinances and subdivision regulations; or to restrict shoreline, floodplain, and wetland development. Data on local government issues and programs can be obtained through relevant local government agencies.

The affected environment section of a NEPA analysis should include as many regulations, criteria, and plans as are relevant to the cumulative effects problems at hand. Federal, state, and local resource and comprehensive plans guiding development activities should be reviewed and, where relevant, used to complete characterization of the affected environment. Agencies' future actions and plans pertaining to the identified resources of concern should be included if they are based on authorized plans or permits issued by a federal, state, or other governmental agency; highly speculative actions should not be included. Agency or regional planning documents can provide the analyst with a reasonable projection of future activities and their modes of operation. How project effects fit within the goals of governmental regulations and planning is an important measure of cumulative effects on the resources, ecosystems, and human communities of the region.

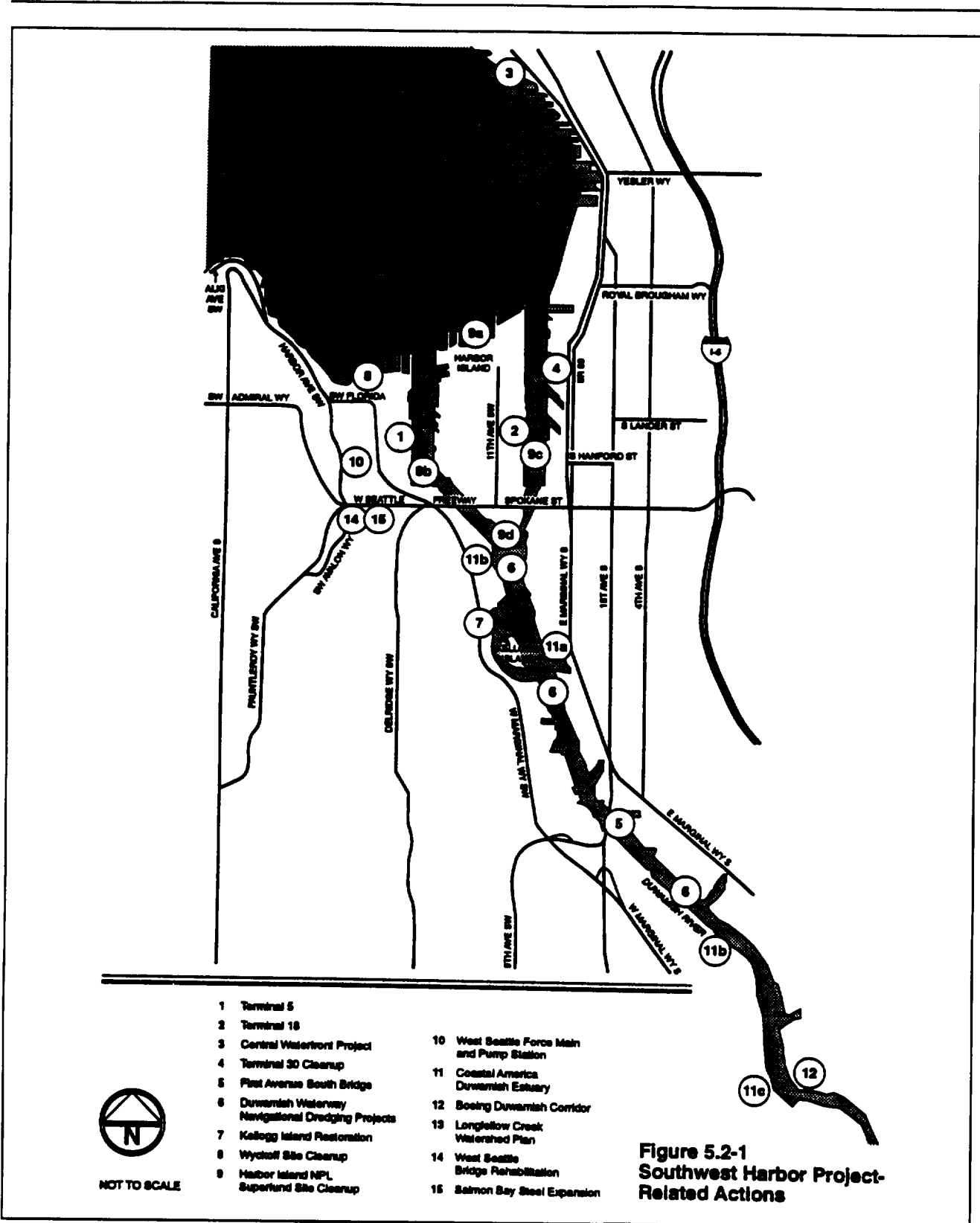

Figure 3-2. Regional map of projects and activities contributing to cumulative effects in Seattle's Southwest Harbor (USACE et al. 1994)

Trends

Cumulative effects occur through the accumulation of effects over varying periods of time. For this reason, an understanding of the historical context of effects is critical to assessing the direct, indirect, and cumulative effects of proposed actions. Trends data can be used in three ways: (1) to establish the baseline for the affected environment more accurately (i.e., by incorporating variation over time), (2) to evaluate the significance of effects relative to historical degradation (i.e., by helping to estimate how close the resource is to a threshold of degradation), and (3) to predict the effects of the action (i.e., by using the model of cause and effects established by past actions).

The ability to identify trends in conditions of resources or in human activities depends on available data. Although data on existing conditions can sometimes be obtained for cumulative effects analysis, analysts can rarely go back in time to collect data (in some cases, lake sediment cores or archaeological excavations can reconstruct relevant historical conditions). Improved technologies for cost-effectively accessing and analyzing data that have been collected in the recent past, however, have been developed. Historical photographs and remotely sensed satellite information can be efficiently analyzed on geographic information systems to reveal trends. The analyst may use these tools to characterize the condition of a resource before contemporary human influences, or the condition at the period when resource degradation was first identified. As shown in Figure 3-3, remote sensing imagery was used to record the change in the condition of the Jemez Mountains, New Mexico (Allen 1994). The 1935 map (left) shows the location of railroads, dirt roads, and primitive roads in the landscape surrounding the Bandelier National Monument. By 1981 (right) the increase in roads and the appearance of several townsites is striking.

This 12-fold increase in total road length is an effective measure of cumulative environmental degradation resulting from the accompanying fire suppression, motorized disturbance of wildlife, creation of habitat edge in forest interiors, and introduction of weedy species along road corridors. The U.S. Forest Service has been using this landscape-scale GIS and remotely sensed information in planning efforts for the Bandelier's headwaters area to ensure that desired forest conditions are maintained (e.g., area and distribution of old growth and densities of snags).

OBTAINING DATA FOR CUMULATIVE EFFECTS ANALYSIS

Obtaining information on cumulative effects issues is often the biggest challenge for the analyst. Gathering data can be expensive and time consuming. Analysts should identify which data are needed for their specific purpose and which are readily available. In some cases, federal agencies or the project proponent will have adequate data; in other cases, local or regional planning agencies may be the best source of information. Public involvement can often direct the analyst to useful information or, itself, serve as an invaluable source of information, especially about the societal setting, which is critical for evaluating effects on human communities. In any case, when information is not available from traditional sources, analysts must be resourceful in seeking alternative sources. Table 3-2 lists some of the possible types and sources of information that may be of use for cumulative effects analysis.

Although most information needed to describe the affected environment must be obtained from regional and local sources, several national data centers are important. Census Bureau publications and statistical abstracts are commonly used for addressing demographic, housing, and general socioeconomic issues, as are several commercial business databases. Currently, an extensive inventory of environmental data coordinated by

The Nature Conservancy through state Natural Heritage Programs (NHPs) and Conservation Data Centers (CDCs) provides the most comprehensive information available about the abundance and distribution of rare species and communities (Jenkins 1988). NHPs and CDCs are continually updated, computer-assisted inventories of the biological and ecological features (i.e., biodiversity elements) of the region in which they are located. These data centers are designed to assist in conservation planning, natural resource management, and environmental impact assessment. Another promising source of data is the U.S. Geological Survey's Biological Resources Division, created

by the consolidation of biological research, inventory and monitoring, and information transfer programs of seven Department of Interior bureaus. The mission of the Division is to gather, analyze, and disseminate the biological information necessary to support sound management of the nation's resources. The U.S. Geological Survey itself was originally created in response to the demands of industry and conservationists for accurate baseline data. Although substantial information can already be obtained from USGS, the implementation of the National Biodiversity Information Infrastructure (NAS 1993) may provide even greater access to comprehensive biological data.

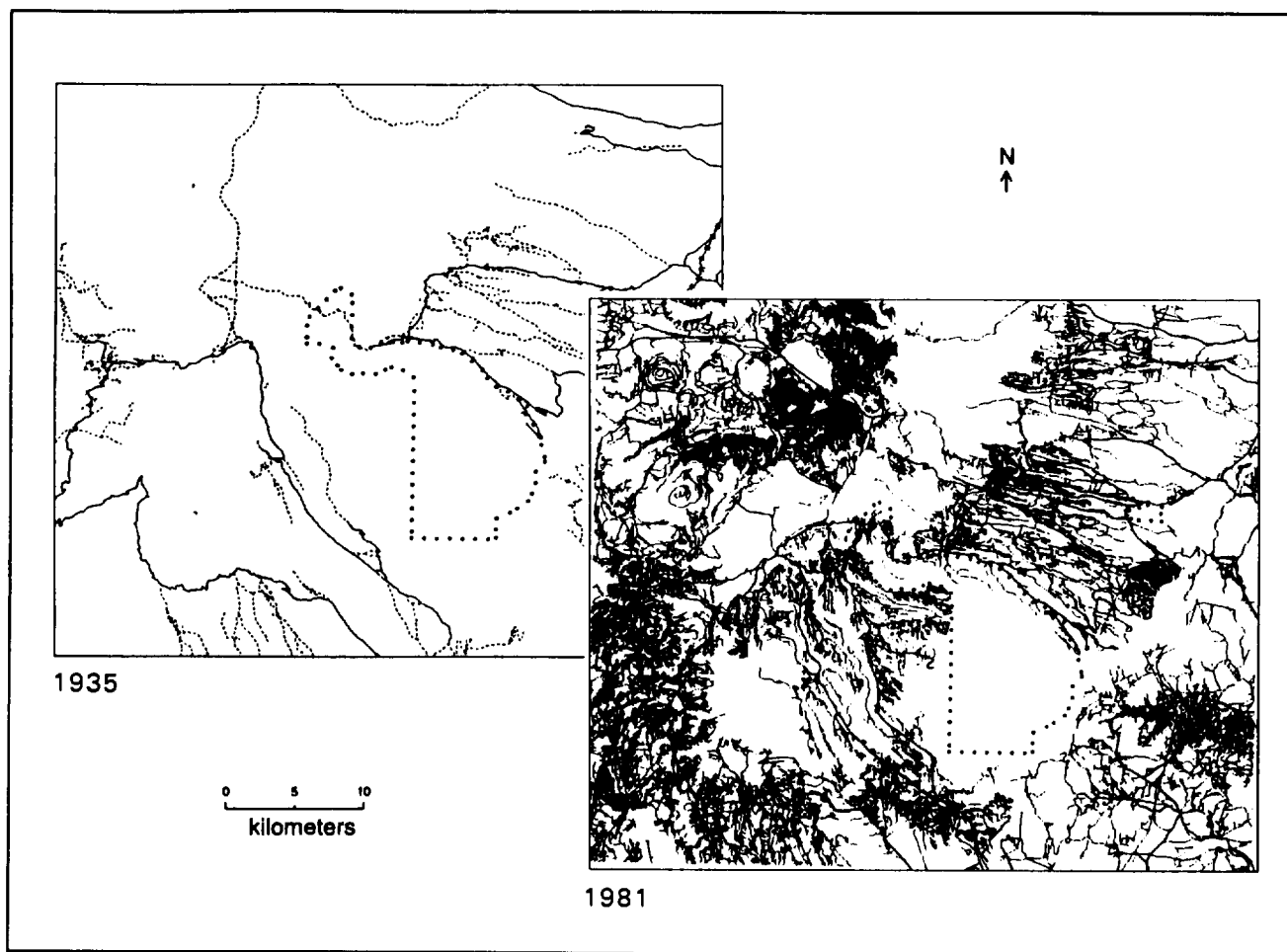

Figure 3-3. Remote sensing imagery illustrating the cumulative increase in roads between 1935 and 1981 across the same 187,858 ha of the Jemez Mountains, New Mexico. The crosshatched line is a railroad; the solid lines are dirt roads; the thin dashed lines are primitive roads' and dotted lines show the current boundary of Bandelier National Monument (Allen 1994).

Table 3-2. Possible sources of existing data for cumulative effects analysis	
Individuals	<ul style="list-style-type: none"> ▪ former and present landholders ▪ long-time residents ▪ long-time resource users ▪ long-time resource managers
Historical societies	Local, state, and regional societies provide: <ul style="list-style-type: none"> ▪ personal journals ▪ photos ▪ newspapers ▪ individual contacts
Schools and universities	<ul style="list-style-type: none"> ▪ central libraries ▪ natural history or cultural resources collections or museums ▪ field stations ▪ faculty in history and natural and social sciences
Other collections	Private, city, state, or federal collections in : <ul style="list-style-type: none"> ▪ archaeology ▪ botany ▪ zoology ▪ natural history
Natural history surveys	<ul style="list-style-type: none"> ▪ private ▪ state ▪ national
Private organizations	<ul style="list-style-type: none"> ▪ land preservation ▪ habitat preservation ▪ conservation ▪ cultural resources history ▪ religious institutions ▪ chambers of commerce ▪ voluntary neighborhood organizations
Government agencies	<ul style="list-style-type: none"> ▪ local park districts ▪ local planning agencies ▪ local records-keeping agencies ▪ state and federal land management agencies ▪ state and federal fish, wildlife, and conservation agencies ▪ state and federal regulatory agencies ▪ state planning agencies ▪ state and federal records-keeping agencies ▪ state and federal surveys ▪ state and federal agricultural and forestry agencies ▪ state historic preservation offices ▪ Indian tribal government planning, natural resource, and cultural resource offices
Project proponent	<ul style="list-style-type: none"> ▪ project plans and supporting environmental documentation

Although federal data sources are critical for compiling baseline data, they have substantial limitations. For the most part, federal environmental data programs have evolved to support a specific agency's missions. They are not designed to capture the interconnections among environmental variables or generate information needed for analyses that cut across sectorial and disciplinary lines. The fact that federal databases are often generated by monitoring programs designed to track progress in meeting regulatory goals further inhibits

integration of data (Irwin and Rodes 1992). The only comprehensive effort to develop estimates of baseline ecological conditions across the United States has been the Environmental Monitoring and Assessment Program (EMAP). EMAP has successfully developed indicators for many resources and has applied them in regional demonstration programs to provide statistically rigorous estimates of the condition of ecosystems. Fully implemented, this program would be invaluable for analyzing cumulative effects (see box).

Defining Baseline Ecological Conditions Through EMAP

Over the last decade, EPA has led a multiagency effort to assess the condition of the nation's ecological resources (Masser et al. 1991). The Environmental Monitoring and Assessment Program (EMAP)'s goal is to identify the extent and magnitude of environmental problems on regional and national scales and to provide information that policy makers, scientists, and the public need to evaluate the success of environmental policies and programs (Thornton et al. 1994). EMAP has developed a scientifically rigorous monitoring design (Overton et al. 1990) within which appropriate indicators (Barber 1994) can be sampled to provide the types of information required to address these questions. EMAP has successfully field tested many of the indicators, sampling protocols, and assessment methods required to evaluate the condition of individual ecological resources (Larsen and Christie 1993; Summers et al. 1993; Weisberg et al. 1993; Lewis and Cankling 1994). Although estimates of the condition of certain resources have been developed for certain regions, EMAP has not yet been implemented on a large scale.

EMAP differs from other monitoring programs in the following ways:

- EMAP focuses on assessing ecological condition by measuring biological indicators. Biological indicators provide integrated measures of response to natural and human-induced stress that cannot be obtained from traditional chemical and physical indicators of environmental stresses such as pollutants and habitat modification. The program maintains a core set of indicators that are implemented nationally with uniform methodology and quality control.
- EMAP uses a statistically rigorous sampling design. By measuring indicators within a network of probability samples rather than from sites selected using subjective criteria, EMAP produces unbiased estimates of the status of and changes in indicators of ecological condition with known confidence.
- EMAP takes an ecosystem-oriented approach to monitoring by sampling several ecological resources. EMAP maintains monitoring efforts in agricultural lands, rangelands, forests, estuaries, and surface waters (i.e., lakes and streams). It also maintains cross-cutting activities in landscape characterization, indicator development, and atmospheric deposition.

These attributes make EMAP uniquely suited to addressing cumulative effects. Where regional estimates of ecological condition have been developed, they can be used as baseline conditions for evaluating the effects of new projects. Although EMAP monitoring is currently limited to a few regions of the country, the EMAP approach is being applied to state monitoring efforts that will establish baseline conditions (see Southerland and Weisberg 1995 for application to Maryland streams).

AFFECTED ENVIRONMENT SUMMARY

The description of the affected environment helps the decisionmaker understand the current conditions and the historical context of the important resources, ecosystems, and human communities. The analyst uses this phase of the NEPA process to characterize the region and determine the methodological complexity required to adequately address cumulative

effects. In describing the affected environment, the cumulative effects analyst should

- identify common cumulative effects issues within the region;
- characterize the current status of the resources, ecosystems, and human communities identified during scoping;
- identify socioeconomic driving variables and indicators of stress on these resources;

-
- characterize the regional landscape in terms of historical and planned development and the constraints of governmental regulations and standards; and
 - define a baseline condition for the resources using historical trends.

The affected environment section should include data on resources, ecosystems, and human communities; environmental and socio-economic stress factors; governmental regulations, standards, and plans; and environmental and social trends. This information will provide the analyst with the baseline and historical context needed to evaluate the environmental consequences of cumulative effects (Chapter 4).

4

DETERMINING THE ENVIRONMENTAL CONSEQUENCES OF CUMULATIVE EFFECTS

PRINCIPLES

- Address additive, countervailing, and synergistic effects.
- Look beyond the life of the action.
- Address the sustainability of resources, ecosystems, and human communities.

The diversity of proposed federal actions and the environments in which they occur make it difficult to develop or recommend a single method or approach to cumulative effects analysis. In this chapter, we attempt to provide insight into and general guidelines for performing analyses needed to determine the environmental consequences of cumulative effects. We assume the analysis has already been scoped, including stipulating geographic and time boundaries (see Chapter 2), and that appropriate data have been gathered for the resources, ecosystems, and human communities of concern (see Chapter 3). Reference is made, when appropriate, to specific cumulative effects analysis methods described in Chapter 5 and Appendix A.

The analyst must ensure that the resources identified during scoping encompass all those needed for an analysis of cumulative effects. The analyst must also ensure that the relevant past, present, and reasonably foreseeable future

actions have been identified. As an iterative process, cumulative effects analysis often identifies additional resources or actions involved in cumulative effects during the analysis phase. In addition to confirming the resources and actions to be considered, the analyst should complete the following specific steps to determine the environmental consequences of the cumulative effects:

Step 8

Identify the important cause-and-effect relationships between human activities and resources, ecosystems, and human communities.

Step 9

Determine the magnitude and significance of cumulative effects.

Step 10

Modify or add alternatives to avoid, minimize, or mitigate significant cumulative effects.

Step 11

Monitor the cumulative effects of the selected alternative and adapt management.

CONFIRMING THE RESOURCES AND ACTIONS TO BE INCLUDED IN THE CUMULATIVE EFFECTS ANALYSIS

Even though scoping has identified likely important cumulative effects, the analyst should include other important cumulative effects that arise from more detailed consider-

ation of environmental consequences. In addition, as the proposed action is modified or other alternatives are developed (usually to avoid or minimize adverse effects), additional or different cumulative effects issues may arise. Specifically, the proposed action and reasonable alternatives (including the no-action alternative) could affect different resources and could affect them in different ways. For instance, hydroelectric facilities primarily affect aquatic resources by blocking fish migration routes, altering thermal regimes, and eroding stream channels as releases fluctuate. Reasonable alternatives for proposed hydroelectric facilities often include various types of power generating facilities that affect the environment in different ways. For example, the effects of coal-fired electric plants are most often related to coal-mining activities, the release of heated water to nearby water bodies in the cooling process, and the release of a variety of pollutants (including greenhouse gases) to the air during combustion. Nuclear plants also release heated water but they release radioactive materials to the air instead of greenhouse gases. Other past, present, or future actions also should be included in the analysis if evaluation of the cause-and-effect relationships identifies additional stresses affecting resources, ecosystems, and human communities of concern.

IDENTIFYING AND DESCRIBING CAUSE-AND-EFFECT RELATIONSHIPS FOR RESOURCES, ECOSYSTEMS, AND HUMAN COMMUNITIES

In preparing any assessment, the analyst should gather information about the cause-and-effect relationships between stresses and resources. The relationship between the percent of fine sediment in a stream bed and the emergence of salmon fry (Figure 4-1) is an example of a model of cause and effect that can be useful for identifying the cumulative effects on a selected resource. Such a model describes the response of the resource to a change in its environment. To determine the consequences of

the proposed action on the resource, the analyst must determine which cumulative environmental changes (e.g., higher sediment load) will result from the proposed action and other actions.

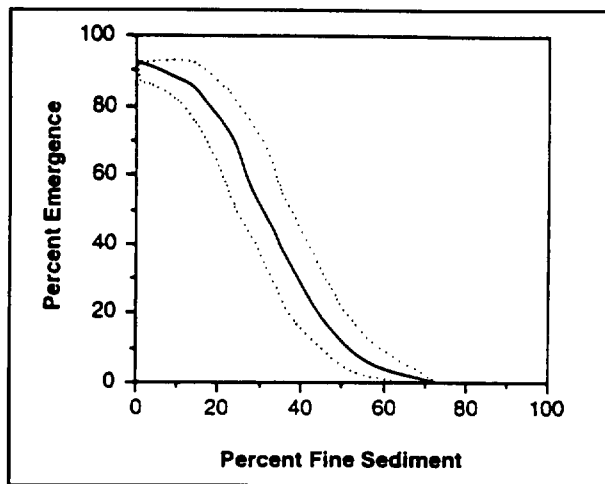

Figure 4-1. Empirical cause and effect relationship between emergence of salmon fry and percent of fine sediment in the stream bottom (Stowell et al. 1983)

Determining the Environmental Changes that Affect Resources

Using information gathered to describe the affected environment, the factors that affect resources (i.e., the causes in the cause-and-effect relationships) can be identified and a conceptual model of cause and effect developed. Networks and system diagrams are the preferred methods of conceptualizing cause-and-effect relationships (see Appendix A). The analyst can develop this model without knowing precisely how the resource responds to environmental change (i.e., the mechanism of the cause-and-effect relationship). If all pathways are identified, the model will be quite complex (Figure 4-2). Such a complex model can seldom be fully analyzed because sufficient data usually are not available to quantify each pathway. Because of this, the model should be simplified to include only important relationships that can be supported by information (Figure 4-3).

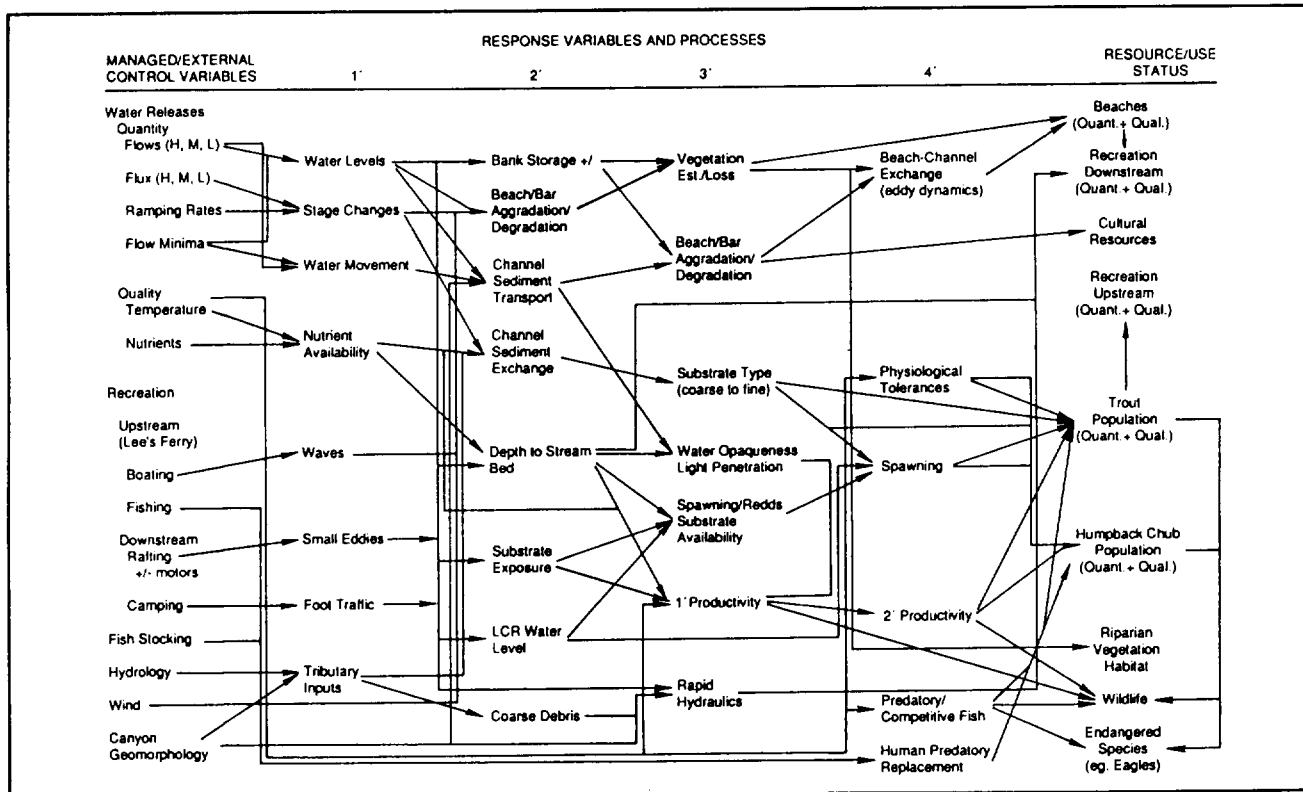

Figure 4-2. Example of a complex model of cause and effect

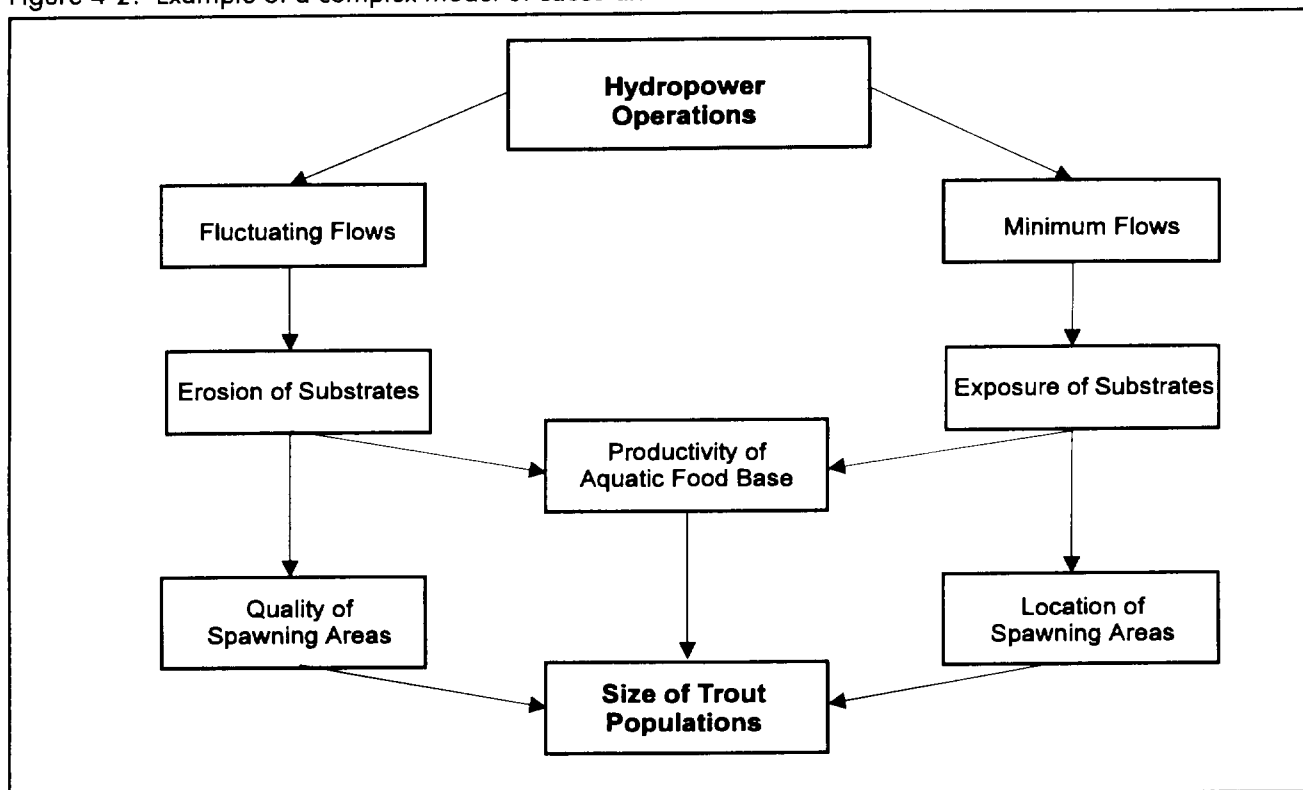

Figure 4-3. Example of a simplified model of cause and effect

The cause-and-effect model can aid in the identification of past, present, and future actions that should be considered in the analysis. In the example shown in Figure 4-3, the analyst should determine if there are other projects in the area that would affect any of the cause-and-effect pathways. The cause-and-effect model for the cumulative effects analysis will often include pathways that would not be needed for a project-specific analysis. Thus, as in defining boundaries, analyzing the consequences of cumulative effects requires broader thinking about the interactions among the activities and resources that affect environmental change.

Determining the Response of the Resource to Environmental Change

Once all of the important cause-and-effect pathways are identified, the analyst should determine how the resource responds to environmental change (i.e., what the effect is). The cause-and-effect relationships for each resource are used to determine the magnitude of the cumulative effect resulting from all actions included in the analysis.

Cause-and-effect relationships can be simple or complex. The magnitude of an effect on a species may depend simply on the amount of habitat that is disturbed. Similarly, effects on archaeological sites may be quantified by enumerating the sites that are disturbed. Other responses may be more complex. The example shown in Figure 4-1 demonstrated that the successful hatching of salmon eggs depends on the percentage of fine particles in the stream bottom in a complex but predictable fashion. Socio-economic models can be applied in a similar way to determine the effects of changes in immigration and emigration rates on the financial condition of a human community.

A wide variety of cause-and-effect evaluation techniques have been described in the literature (see Chapter 5). Techniques for evaluating ecological resources include the set of Habitat Suitability Index Models (HSI;

Schamberger et al. 1982; Hayes 1989) developed by the U.S. Fish and Wildlife Service for its Habitat Evaluation Procedures (HEP; U.S. Fish and Wildlife Service 1980). These models use cause-and-effect relationships for several key environmental variables to determine the suitability of different habitats for a variety of species. The change in number of habitat units (i.e., the ability of an area to support a species) as a result of multiple actions is a useful measure of cumulative effects. Species habitat models also drive the Habitat Evaluation System of the U.S. Army Corps of Engineers (1980). For wetland habitat designations, the Wetland Evaluation Technique is often used (Adamus et al. 1987). Other methods for linking measures of environmental change to effects on resources include developing relationships between loss in wetland area and functions such as flood storage, water quality, and life support (Preston and Bedford 1988; Leibowitz et al. 1992) and linking hydrology first to vegetation and then to wildlife habitat (Nestler 1992).

Nonlinear cause-and-effect relationships among several environmental changes pose an additional challenge for the analyst. A common example is the synergistic effect on fish populations that results from the combination of direct mortality losses to hydropower turbines and increased predation losses that occur as predators are attracted to dead and stunned fish. The analyst may also have to predict additional fish mortality from disease as a result of reductions in immune responses caused by toxic contamination. A third example of a common cumulative cause-and-effect problem is the combined effect on dissolved oxygen levels of excessive algal growth resulting from both increased nutrient loading and higher temperatures.

One of the most useful approaches for determining the likely response of the resource, ecosystem, and human community to environmental change is to evaluate the historical effects of activities similar to those under consideration. In the case of road construction through a

forest, the effects of similar past actions such as the construction of pipelines and power lines may provide a basis for predicting the likely effects of the proposed road construction. The residual effects of constructing and operating these linear facilities include fragmentation of forest tracts and the creation of homogeneous vegetation in the rights-of-way. Trends analysis (see Appendix A) can be used to model the effects of linear facilities over time and extrapolate the effects of a road construction project into the future.

If cause-and-effect relationships cannot be quantified, or if quantification is not needed to adequately characterize the consequences of each alternative, qualitative evaluation procedures can be used. The analyst may categorize the magnitude of effects into a set number of classes (e.g., high, medium, or low) or provide a descriptive narrative of the types of effects that may occur. Often, the analyst will be limited to qualitative evaluations of effects because cause-and-effect relationships are poorly understood or because few site-specific data are available. Even when the analyst cannot quantify cumulative effects, a useful comparison of relative effects can enable a decisionmaker to choose among alternatives.

DETERMINING THE MAGNITUDE AND SIGNIFICANCE OF CUMULATIVE EFFECTS

The analyst's primary goal is to determine the magnitude and significance of the environmental consequences of the proposed action in the context of the cumulative effects of other past, present, and future actions. To accomplish this, the analyst must use a conceptual model of the important resources, actions, and their cause-and-effect relationships. The critical element in this conceptual model is defining an appropriate baseline or threshold condition of the resource, ecosystem, and human community beyond which adverse or beneficial change would cause significant degradation or enhancement of the resource, respectively.

The concept of a baseline against which to compare predictions of the effects of the proposed action and reasonable alternatives is critical to the NEPA process. The no-action alternative is an effective construct for this purpose, but its characterization is often inadequate for analyzing cumulative effects. Much of the environment has been greatly modified by human activities, and most resources, ecosystems, and human communities are in the process of change as a result of cumulative effects. The analyst must determine the realistic potential for the resource to sustain itself in the future and whether the proposed action will affect this potential; therefore, the baseline condition of the resource of concern should include a description of how conditions have changed over time and how they are likely to change in the future without the proposed action.

The potential for a resource, ecosystem, and human community to sustain its structure and function depends on its resistance to stress and its ability to recover (i.e., its resilience). Determining whether the condition of the resource is within the range of natural variability or is vulnerable to rapid degradation is frequently problematic. Ideally, the analyst can identify a threshold beyond which change in the resource condition is detrimental. More often, the analyst must review the history of that resource and evaluate whether past degradation may place it near such a threshold. For example, the loss of 50% of historical wetlands within a watershed may indicate that further losses would significantly affect the capacity of the watershed to withstand floods. It is often the case that when a large proportion of a resource is lost, the system nears collapse as the surviving portion is pressed into service to perform more functions.

The baseline condition should also include other present (ongoing) actions. For example, the National Ambient Air Quality Standards (NAAQS) inventory represents the universe of

present actions used in air quality analyses to determine whether new emission sources will exceed air quality standards. The NAAQS inventory includes all existing emission sources, sources with Prevention of Significant Deterioration (PSD) permits that have not yet begun to operate, and applicants for whom a PSD permit has not yet been issued. The NAAQS analysis requires explicitly modeling all existing nearby sources (as far away as 50 kilometers) be for air quality effects. In the analysis of the cause-and-effect relationships related to the anticipated impacts, each source represents a cause, and their combined emissions create an effect on air quality, the significance of which can be determined by comparing the concentration of pollutants emitted to threshold concentrations specified in the NAAQS. The NAAQS thresholds are concentrations known to cause significant human health or other environmental effects.

The historical context and full suite of ongoing actions are not only critical for evaluating cumulative effects, but also for developing potential restoration as well. The first step in developing a river restoration plan is to understand how past actions (e.g., contributions of contaminants to the watershed) have contributed to the current condition of the water body. The historical trends in resource condition and its current potential for sustained structure and function are an essential frame of reference for developing mitigation and enhancement measures.

Determining Magnitude

Initially, the analyst will usually determine the separate effects of past actions, present actions, the proposed action (and reasonable alternatives), and other future actions. Once each group of effects is determined, cumulative effects can be calculated. The cumulative effects on a specific resource, however, will not necessarily be the sum of the effects of all

actions. Knowing how a particular resource responds to environmental change (i.e., the cause-and-effect relationship) is essential for determining the cumulative effect of multiple actions. Will the effects of two or more actions be additive, i.e., if one project would result in the death of 25% of a trout population (within a given level of uncertainty) and another the death of 10% of the trout, would the two projects together result in the loss of 35% of the trout? Although this is sometimes the case, there are often instances where the cause-and-effect relationship is more complex, i.e., the cumulative effect of two projects may be greater than the sum of the effects of each (in the trout example, more than 35% of the trout would die) or less than their sum (less than 35% of the trout would die). In some cases, the resource may better withstand additional adverse effects as stress increases, while in others, the resource may crash once a threshold is reached.

Once effects are identified using one of the methodologies described in Chapter 5, a table can be used to itemize effects into categories of past, present, proposed, and future actions. Tables 4-1, 4-2, and 4-3 show how these tables can be constructed using the results from different types of analyses. Regardless of the degree of quantification used, such tables are useful tools for putting the effects of the proposed action and alternatives into proper context. Table 4-1 illustrates the net cumulative effects of combining fish population increases from the proposed action with population losses from past and future actions. The table could be expanded to include the countervailing effect of sulfate aerosols on global warming (because they compensate for greenhouse gases) at the same time they are degrading ambient air quality. A series of such tables (one for each alternative) enables the analyst to compare alternatives meaningfully.

Table 4-1. Example table using quantitative description of effects (within a given level of uncertainty) on various resources

Resource	Past Actions	Present Actions	Proposed Action	Future Actions	Cumulative Effect
Air Quality	No effect on SO ₂	20% increase in SO ₂	10% increase in SO ₂	5% increase in SO ₂	35% increase in SO ₂
Fish	50% of 1950 population lost	2% of fish population lost	5% increase in fish population	1% of fish population lost	48% of 1950 fish population lost
Wetlands	78% of presettlement wetlands lost	1% of existing wetlands lost annually for 5 years	0.5% of existing wetlands lost	1.5% of existing wetlands lost annually for 10 years	95% of presettlement wetlands lost in 10 years

The separation of effects into those attributable to the proposed action or a reasonable alternative versus those attributable to past and future actions also allows the analyst to determine the incremental contribution of each alternative. Situations can arise where an incremental effect that exceeds the threshold of concern for cumulative effects results, not from the proposed action, but from reasonably foreseeable but still uncertain future actions. Although this situation is generally unexplored, the decisionmaker is faced with determining whether to forgo or modify the proposed action to permit other future actions. Identifying incremental effects, therefore, is an important part of informing the decisionmaker.

Most cumulative effects analyses will identify varying levels of beneficial and adverse effects depending on the resource and the individual action. Aquatic species will experience entirely different effects from terrestrial ones. A warm water fishery (e.g., largemouth bass) may benefit from a change that is detrimental to a cold water fishery (e.g., trout), and effects that are beneficial to the well being of a human community (e.g., provision of social services) may be detrimental to natural systems (e.g., wetlands lost during construction of a hospital).

Because of this mixture of beneficial and adverse effects, the decisionmaker is often hard pressed to determine which alternative is environmentally preferred. To overcome this problem, indices of overall cumulative effect can be developed. Some of the matrix methods used in cumulative effects analysis were developed specifically to address this need. These methods use unitless measures of effect (e.g., scales or ranks) to get around the problem of combining results from a variety of resources.

Presentation of overall cumulative effects can be controversial. Intentional or unintentional manipulation of assumptions can dramatically alter the results of aggregated indices (Bisset 1983), and experience indicates that complex quantitative methods for evaluating cumulative effects make it more difficult for the public to understand and accept the results. Effects on resources are usually presented separately, and professional judgment is used in determining the reasonable alternative with the greatest net positive cumulative effect. The U.S. EPA has developed guidelines for addressing specific kinds of risks (including cancer risks and the risks posed by chemical mixtures) and for comparing disparate kinds of risks (U.S. EPA 1993).

Table 4-2. Example table using qualitative description of effects on various resources, with impact ranks assigned a value from 1 to 5 (least to greatest)

Resource	Past Actions	Present Actions	Proposed Action	Future Actions	Cumulative Effect
Air Quality	1	2	1	1	2
Fish	3	2	1	1	4
Wetlands	4	1	1	1	4

Table 4-3. Example table using narrative description of effects on various resources

Resource	Past Actions	Present Actions	Proposed Action	Future Actions	Cumulative Effect
Air Quality	Impacts dissipated	Noticeable deterioration in visibility during summer, but standards met	Visibility affected during operations, but standards met	Increase in auto emissions expected	Standards possibly violated
Fish	Decrease in numbers and species diversity	Occasional documented fish kills	Increase in number of fish kills	Loss of cold-water species due to change in temperature	Significant decline in numbers and species diversity
Wetlands	Large reduction in acreage of wetlands	Loss of small amount of wetland annually	Disturbance of a 5 acre wetland	Continued loss of wetlands	Significant cumulative loss of wetlands

Determining Significance

The significance of effects should be determined based on context and intensity. In its implementing regulations for NEPA, CEQ states that "the significance of an action must be analyzed in several contexts such as society as a whole (human, national), the affected region, the affected interests, and the locality" (40 CFR § 1508.27). Significance may vary with the setting of the proposed action.

Intensity refers to the severity of effect (40 CFR § 1508.27). Factors that have been used to define the intensity of effects include the

magnitude, geographic extent, duration, and frequency of the effects. As discussed above, the **magnitude** of an effect reflects relative size or amount of an effect. **Geographic extent** considers how widespread the effect might be. **Duration and frequency** refers to whether the effect is a one-time event, intermittent, or chronic. Where a quantitative evaluation is possible, specific criteria for significance should be explicitly identified and described. These criteria should reflect the resilience of the resource, ecosystem, and human community to the effects that are likely to occur.

Thresholds and criteria (i.e., levels of acceptable change) used to determine the significance of effects will vary depending on the type of resource being analyzed, the condition of the resource, and the importance of the resource as an issue (as identified through scoping). Criteria can be quantitative units of measure such as those used to determine threshold values in economic impact modeling, or qualitative units of measure such as the perceptions of visitors to a recreational area. No matter how the criteria are derived, they should be directly related to the relevant cause-and-effect relationships. The criteria used, including quantitative thresholds if appropriate, should be clearly stated in the assessment document.

Determinations of significance in an EA or an EIS are the focus of analysis because they lead to additional (more costly) analysis or to inclusion of additional mitigation (or a detailed justification for not implementing mitigation). The significance of adverse cumulative effects is a sensitive issue because the means to modify contributing actions are often outside the purview of the proponent agency. Currently, agencies are attempting to deal with this difficult issue by improving their analysis of historical trends in resource and ecosystem condition. Even where cumulative effects are not deemed to be significant, better characterization of historical changes in the resource can lead to improved designs for resource enhancement. Where projected adverse effects remain highly uncertain, agencies can implement adaptive management—flexible project implementation that increases or decreases mitigation based on monitoring results.

AVOIDING, MINIMIZING, AND MITIGATING SIGNIFICANT CUMULATIVE EFFECTS

If it is determined that significant cumulative effects would occur as a result of a proposed action, the project proponent should avoid,

minimize, or mitigate adverse effects by modifying or adding alternatives. The proponent should not overlook opportunities to enhance resources when adverse cumulative effects are not significant. The separation of responsibilities for actions contributing to cumulative effects makes designing appropriate mitigation especially difficult. In the case of the Lackawanna Industrial Highway, the Federal Highway Administration and Pennsylvania Department of Transportation sponsored development of a comprehensive plan for the valley that provides a mechanism for ensuring that secondary development accompanying construction of the highway would protect valued resources, ecosystems, and human communities (see box).

By analyzing the cause-and-effect relationships resulting in cumulative effects, strategies to mitigate effects or enhance resources can be developed. For each resource, ecosystem, and human community of concern, the key to developing constructive mitigation strategies is determining which of the cause-and-effect pathways results in the greatest effect. Mitigation and enhancement strategies that focus on those pathways will be the most effective for reducing cumulative effects.

It is sometimes more cost-effective to mitigate significant effects after they occur. This might involve containing and cleaning up a spill, or restoring a wetland after it has been degraded. In most cases, however, avoidance or minimization are more effective than remediating unwanted effects. For example, attempting to remove contaminants from air or water is much less effective than preventing pollution discharges into an airshed or watershed. Although such preventative approaches can be the most (or only) effective means of controlling cumulative effects, they may require extensive coordination at the regional or national scale (e.g., federal pollution control statutes).

Mitigating the Secondary and Cumulative Effects of the Lackawanna Valley Industrial Highway

Cumulative effects analysis conducted as part of the EIS for construction of a 16-mile-long, multi-lane, limited access highway in the Lackawanna Valley of Pennsylvania predicted substantial secondary environmental consequences from the expected (and desired) economic development in the valley. Specifically, additional industrial, commercial, and housing development would accompany the economic activity, producing higher demands on the valley's circulation system as well as on central water and sewer services and on other types of community services as well. To ensure that the development occurring as a result of the highway's construction would take place in an environmentally-sensitive manner, the Lackawanna Valley Corridor Plan was developed. This plan was a cooperative study sponsored by the Federal Highway Administration, Pennsylvania Department of Transportation, Pennsylvania Department of Community Affairs, and Lackawanna County through the Lackawanna County Regional Planning Commission (1996). The study produced an overall framework for the future development of the valley, including a Land Use Plan and a Circulation Plan, and a series of land development regulations that may be implemented by valley municipalities to ensure that new development protects community values and environmental resources. By undertaking the Lackawanna Valley Corridor Plan as part of the environmental decisionmaking process for the Lackawanna Valley Industrial Highway, the responsible federal and state agencies provided a concrete mechanism to avoid, minimize, and mitigate potentially adverse cumulative effects from secondary actions beyond their direct control.

ADDRESSING UNCERTAINTY THROUGH MONITORING AND ADAPTIVE MANAGEMENT

The complexity of cumulative effects problems ensures that even rigorous analyses will contain substantial uncertainties about predicted environmental consequences (Carpenter 1995a). Risk assessment methods offer effective ways of presenting the uncertainties to decisionmakers (Carpenter 1995b), and increased scientific knowledge and improved analytical capabilities using modern computers and GIS can help reduce this uncertainty. Nonetheless, both researchers and practitioners generally agree that monitoring is critical to assess the accuracy of predictions of effects and ensure the success of mitigations (Canter 1993). Monitoring provides the means to identify the need for modifying (increasing or decreasing) mitigation, and adaptive management provides the flexible program for achieving these changes. An efficient, cost-effective approach to adaptive management is to sequentially implement mitigation measures so that the measures can be changed as needed (Carpenter 1995c).

It is important to remember that the goal of the NEPA process is to reduce adverse environmental effects (or maximize the net beneficial effect), including cumulative effects. Cumulative effects analysis, therefore, should be an iterative process in which consequences are assessed repeatedly following incorporation of avoidance, minimization, and mitigation measures into the alternatives. In this way, monitoring is the last step in determining the cumulative effects that ultimately result from the action. Important components of a monitoring program for assessing cumulative effects include the following:

- measurable indicators of the magnitude and direction of ecological and social change,
- appropriate timeframe,

-
- appropriate spatial scale,
 - means of assessing causality,
 - means of measuring mitigation efficacy, and
 - provisions for adaptive management.

ENVIRONMENTAL CONSEQUENCES SUMMARY

Although cumulative effects analysis is similar in many ways to the analysis of project-specific effects, there are key differences. To determine the environmental, social, and economic consequences of cumulative effects, the analyst should

- Select the resources, ecosystems, and human communities considered in the project-specific analysis to be those that could be affected cumulatively.
- Identify the important cause-and-effect relationships between human activities and resources of concern using a network or systems diagram that focuses on the important cumulative effects pathways.
- Adjust the geographic and time boundaries of the analysis based on cumulative cause-and-effect relationships.
- Incorporate additional past, present, and reasonably foreseeable actions into the analysis as indicated by the cumulative cause-and-effect relationships.

- Determine the magnitude and significance of cumulative effects based on context and intensity and present tables comparing the effects of the proposed action and alternatives to facilitate decisionmaking.
- Modify or add alternatives to avoid, minimize, or mitigate cumulative effects based on the cause-and-effect pathways that contribute most to the cumulative effect on a resource.
- Determine cumulative effects of the selected alternative with mitigation and enhancement measures.
- Explicitly address uncertainty in communicating predictions to decisionmakers and the public, and reduce uncertainty as much as possible through monitoring and adaptive management.

Determining the environmental consequences entails describing the cause-and-effect relationships producing cumulative effects and summarizing the total effect of each alternative. These activities require developing a cumulative effects analysis methodology (Chapter 5) from available methods, techniques, and tools of analysis (Appendix A).

5

METHODS, TECHNIQUES, AND TOOLS FOR ANALYZING CUMULATIVE EFFECTS

Analyzing cumulative effects under NEPA is conceptually straightforward but practically difficult. Fortunately, the methods, techniques, and tools available for environmental impact assessment can be used in cumulative effects analysis. These methods are valuable in all phases of analysis and can be used to develop the conceptual framework for evaluating the cumulative environmental consequences, designing appropriate mitigations or enhancements, and presenting the results to the decisionmaker.

This chapter introduces the reader to the literature on cumulative effects analysis and discusses the incorporation of individual methods into an analytical methodology. Appendix A provides summaries of 11 methods for analyzing cumulative effects. The research and environmental impact assessment communities continue to make important contributions to the field. In addition to methods developed explicitly for environmental impact assessment, valuable new approaches to solving cumulative effects problems are being put forth by practitioners of ecological risk assessment (Suter 1993; U.S. EPA 1992; U.S. EPA 1996), regional risk assessment (Hunsaker et al. 1990), and environmental planning (Williamson 1993; Vestal et al. 1995). Analysts should use this chapter and Appendix A as a starting point for further research into methods, techniques, and tools that can be applied to their projects.

LITERATURE ON CUMULATIVE EFFECTS ANALYSIS METHODS

Several authors have reviewed the wide variety of methods for analyzing cumulative effects that have been developed over the last 25 years (see Horak et al. 1983; Witmer et al. 1985; Granholm et al. 1987; Lane and Wallace 1988; Williamson and Hamilton 1989; Irwin and Rodes 1992; Leibowitz et al. 1992; Hochberg et al. 1993; Burris 1994; Canter and Kamath 1995; Cooper 1995; Vestal et al. 1995). In a review of 90 individual methods, Granholm et al. (1987) determined that none of even the 12 most promising methods met all of the criteria for cumulative effects analysis. Most of the methods were good at describing or defining the problem, but they were poor at quantifying cumulative effects. No one method was deemed appropriate for all types or all phases of cumulative effects analysis. In general, these authors grouped existing cumulative effects analysis methods into the following categories:

- those that describe or model the cause-and-effect relationships of interest, often through matrices or flow diagrams (see Bain et al. 1986; Armour and Williamson 1988; Emery 1986; Patterson and Whillans 1984);

- those that analyze the trends in effects or resource change over time (see Contant and Ortolano 1985; Gosselink et al. 1990); and
- those that overlay landscape features to identify areas of sensitivity, value, or past losses (see McHarg 1969; Bastedo et al. 1984; Radbruch-Hall et al. 1987; Canters et al. 1991).

These methods address important aspects of considering multiple actions and multiple effects on resources of concern, but they do not constitute a complete approach to cumulative effects analysis. General analytical frameworks for analysis have been developed for the U.S. Army Corp of Engineers (Stakhiv 1991), U.S. Fish and Wildlife Service (Horak et al. 1983), Department of Energy (Stull et al. 1987), U.S. Environmental Protection Agency (Bedford and Preston 1988), and the Canadian Government (Lane and Wallace 1988). In addition, the U.S. EPA and the National Oceanic and Atmospheric Administration have developed two specific approaches to address the problems of cumulative wetlands loss (Leibowitz et al. 1992; Vestal et al. 1995).

These methods usually take one of two basic approaches to addressing cumulative effects (Spaling and Smit 1993; Canter 1994):

- **Impact assessment approach**, which analytically evaluates the cumulative effects of combined actions relative to thresholds of concern for resources or ecosystems.
- **Planning approach**, which optimizes the allocation of cumulative stresses on the resources or ecosystems within a region.

The first approach views cumulative effects analysis as an extension of environmental impact assessment (e.g., Bronson et al. 1991; Conover et al. 1985); the second approach regards cumulative effects analysis as a correlate of regional or comprehensive planning

(e.g., Bardecki 1990; Hubbard 1990; Stakhiv 1988; 1991). Although the impact assessment approach more closely parallels current NEPA practice, an optimizing approach based on a community-derived vision of future conditions may be preferable in the absence of reliable thresholds for the resources, ecosystems, and human communities of concern. In fact, the planning approach to cumulative effects analysis is becoming more common within agencies and intergovernmental bodies as they embrace the principles of ecosystem management (IEMTF 1995) and sustainable development. These two approaches are complementary and together constitute a more complete cumulative effects analysis methodology, one that satisfies the NEPA mandate to merge environmental impact assessment with the planning process.

IMPLEMENTING A CUMULATIVE EFFECTS ANALYSIS METHODOLOGY

Although the NEPA practitioner must draw from the available methods, techniques, and tools it is important to understand that a study-specific methodology is necessary. Designing a study-specific methodology entails using a variety of methods to develop a conceptual framework for the analysis. The conceptual framework should constitute a general causal model of cumulative effects that incorporates information on the causes, processes, and effects involved. A set of primary methods can be used to describe the cumulative effects study in terms of multiple causation, interactive processes, and temporally and spatially variable effects.

The **primary methods** for developing the conceptual causal model for a cumulative effects study are

1

Questionnaires, interviews, and panels to gather information about the wide range of actions and effects needed for a cumulative effects analysis.

2

Checklists to identify potential cumulative effects by reviewing important human activities and potentially affected resources.

- 3

Matrices to determine the cumulative effects on resources, ecosystems, and human communities by combining individual effects from different actions.
- 4

Networks and system diagrams to trace the multiple, subsidiary effects of various actions that accumulate upon resources, ecosystems, and human communities.
- 5

Modeling to quantify the cause-and-effect relationships leading to cumulative effects.
- 6

Trends analysis to assess the status of resources, ecosystems, and human communities over time and identify cumulative effects problems, establish appropriate environmental baselines, or project future cumulative effects.
- 7

Overlay mapping and GIS to incorporate locational information into cumulative effects analysis and help set the boundaries of the analysis, analyze landscape parameters, and identify areas where effects will be the greatest.

After developing the conceptual framework, the analyst must choose a method to determine and evaluate the cumulative effects of project actions. This method must provide a procedure for aggregating information across multiple resources and projects in order to draw conclusions or recommendations. The simplest method is the comparison of project (or program) alternatives qualitatively or quantitatively in tabular form.

Tables and matrices use columns and rows to organize effects and link activities (or alternatives) with resources, ecosystems, and human communities of concern. The relative effects of various activities can be determined by comparing the values in the cells of a table. The attributes of each cell can be descriptive or numerical. Tables are commonly used to present proposed actions and reasonable alternatives (including no-action) and their respective effects on resources of concern. Tables can be used to organize the full range of environmental, economic, and social effects. Depending on how the table is constructed, a cell may

represent a combination of activities and, therefore, be cumulative, or it may include a separate column for cumulative effects.

Cumulative effects are increasingly appearing as a separate column in EISs. In the case of the cumulative mining effects in the Yukon-Charley Rivers National Preserve, Alaska (National Park Service 1990), the estimated effect of the proposed mining actions on each resource (e.g., riparian wildlife habitat) was evaluated both as a direct effect and as a cumulative effect in combination with past mining losses. Quantitative short-term and long-term effects (in acres) were calculated (Table 5-1). In the case of the Pacific yew (U.S. Forest Service 1993), the potential direct, indirect, and cumulative effects on the genetic resource of the Pacific yew were summarized qualitatively (e.g., risk of genetic erosion at edge of range; Table 5-2).

Some tables are designed explicitly to aggregate effects across resources (including weighting different effects). Grand indices that combine effects include the Environmental Evaluation System (Dee et al. 1973) and ecological rating systems for wildlife habitat and other natural areas (e.g., Helliwell 1969, 1973). Such approaches have been relatively unsuccessful because intentional or unintentional manipulation of assumptions can dramatically alter the results of aggregated indices (Bisset 1983), and because complex quantitative methods for evaluating cumulative effects make it more difficult for the public to understand and accept the results. Westman (1985) concluded that aggregation and weighting of effects should be rejected in favor of providing information in a qualitative, disaggregated form. Although it may not be possible to combine highly disparate resource effects, different resource effects that cumulatively affect interconnected systems must be addressed in combination. In any case, greater efforts need to be made to present the full suite of adverse and beneficial effects to the decisionmaker so that comparisons are clear and understandable.

Table 5-1. Cumulative effects of mining on riparian habitat in Yukon-Charley National Preserve, Alaska (National Park Service 1990)

Study Area Drainage	Habitat (acres)		Long-Term Impacts (acres)			Short-Term Impacts (acres)	
	Premining	Existing (% Premining)	Past Mining Loss	Alternative A Loss	Cumulative Loss	Alternative A Loss	Cumulative Loss
Wood chopper	1,227	1,101(89.7)	126	30	156	26	182
Coal	2,081	1,376 (66.1)	705	20	725	14	739
Sam	1,158	1,148 (99.1)	10	20	30	11	41
TOTAL	4,446	3,615 (81.2)	841	70	911	51	962
Fourth of July	833	777 (93.3)	56	20	76	16	92
GRAND TOTAL	5,299	4,402 (83.1)	897	90	987	67	1,054

Table 5-2. Cumulative effects on the genetic resources of the Pacific yew (U.S. Forest Service 1993)

Alternative	Direct Effects on Existing Levels of Genetic Variation	Indirect Effects on Levels of Genetic Variation in Future Generations	Cumulative Effects
A	Risk of losing small populations at edge of range, thereby reducing existing levels.	Risk of losing small populations at edge of range, thereby reducing future levels.	Risk of genetic erosion at edge of range.
B	None.	None.	Would negate risk to small populations and halt genetic erosion.
C	Risk of slightly reducing levels within population for some populations. No effect on overall variation.	Risk of slightly reducing some populations. No effect on overall variation or values.	Would enhance gene variation.
D	Within population levels could be reduced more than in Alt. C. No effect on overall genetic variation.	Could be reduced more than in Alt. C. for some populations. No overall effect.	Same as Alt. C.
F	Within population levels could be reduced more than in Alt. D. Overall levels of variation would be reduced slightly.	Could be reduced more than in Alt. D. Potential significant reduction in adaptability of some populations and some reduction in values.	Same as Alt. C.
G 1	Same as Alt. D.	Same as Alt. D.	Same as Alt. C
G 2	Same as Alt. D.	Same as Alt. D.	Gene conservation would not be well served because of fewer reserves.

Although tables and matrices are the most common method for evaluating the cumulative effect of alternatives, map overlays and modeling can be used to summarize and evaluate cumulative effects.

In general, the standard environmental impact assessment methods described above can be combined effectively to address cumulative effects (Figure 5-1). Two aspects of cumulative effects analysis, however, warrant special analysis methods: (1) the need to address resource sustainability, and (2) the need to focus on integrated ecosystems and human communities. By definition, cumulative effects analysis involves comparing the combined effect with the capacity of the resource, ecosystem, and human community to

withstand stress. **Carrying capacity analysis** has been applied to a wide range of resources to address cumulative effects. Cumulative effects are a more complex problem for whole ecosystems, because ecosystems are subject to the widest possible range of direct and indirect effects. Analyzing the cumulative effects on ecosystems requires a better understanding of the interworkings of ecological systems and a more holistic perspective. Specifically, **ecosystem analysis** entails new indicators of ecological conditions including landscape-scale measures. In addition to these two special methods, analyzing cumulative effects on human communities requires specific **economic impact analysis** and **social impact analysis methods**.

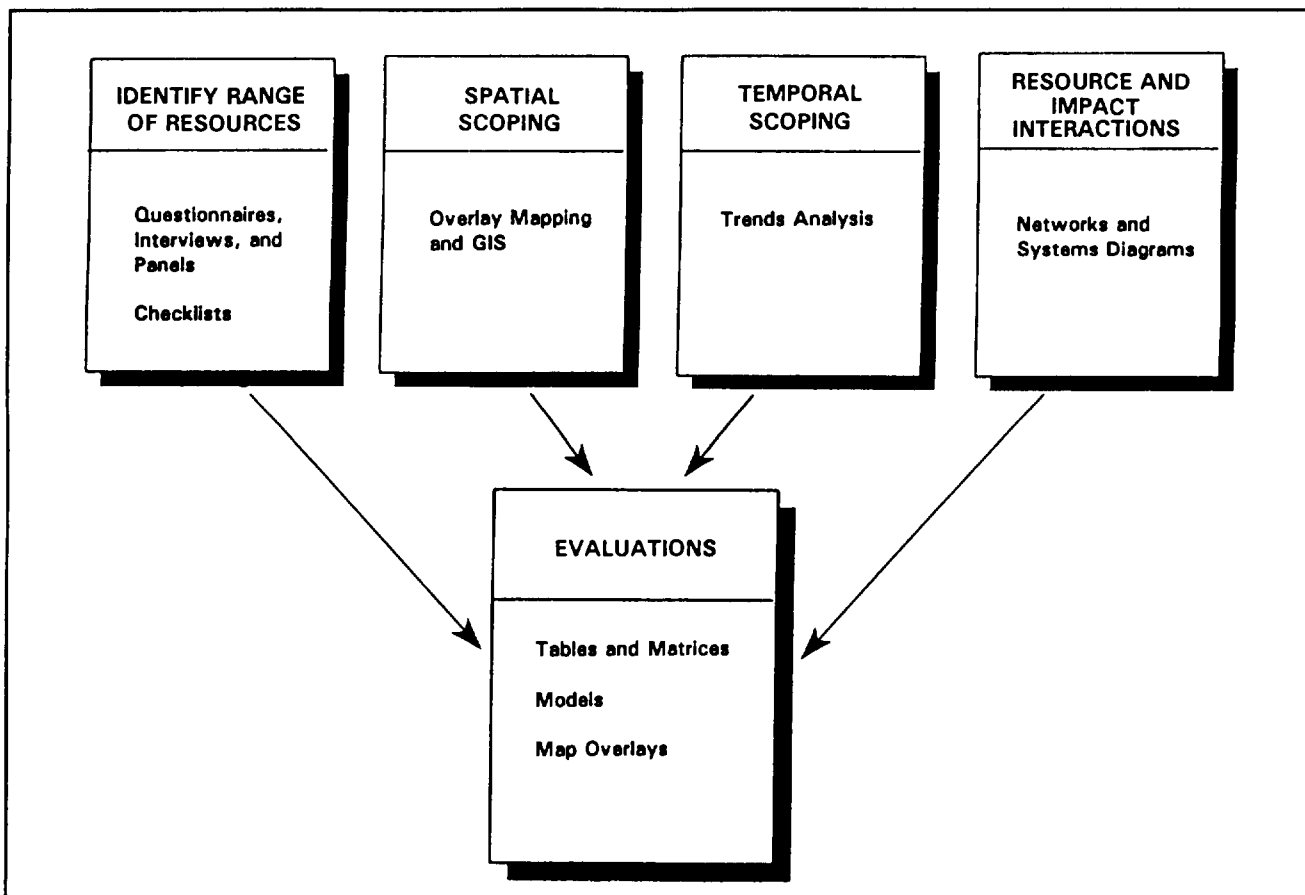

Figure 5-1. Conceptual model for combining primary methods into a cumulative effects analysis

In addition to the primary and special methods discussed above, there are several tools that can be used to conduct or illustrate cumulative effects analysis. The most important are modern computers with capabilities for storing, manipulating, and displaying large amounts of data. Although simple tables, graphs, and hand-drawn maps are adequate for many analyses, powerful computers can facilitate the use of multidimensional matrices and sophisticated models that require solving complex equations or conducting simulations. General tools for illustrating cumulative effects include dose-response curves, cumulative frequency distributions, maps, and videography. Video simulation, wherein an existing site is captured through imagery and electronically altered to show how the site will look after a proposed action is implemented, is a promising new technology for analyzing effects and communicating them to the public (Marlatt et al. 1993).

Most importantly, **geographic information systems (GIS)** can manipulate and display the location-specific data needed for cumulative effects analysis. GIS can be used to manage large data sets, overlay data and analyze development and natural resource patterns, analyze trends, use mathematical models of effect with locational data, perform habitat analysis, perform aesthetic analysis, and improve public consultation (Eedy 1995). GIS can incorporate a statistically reliable locational component into virtually any cumulative effects analysis. Unlike manual mapping systems, the scale can be adjusted and the data layers easily updated. Once a GIS has been developed, it can drastically reduce the effort needed to analyze the effects of future projects, i.e., each new development proposal can be readily overlain on existing data layers to evaluate cumulative effects (Johnston et al. 1988).

Effective use of the increased analytical and presentation capabilities of computers and GIS requires large amounts of data. Fortunately, available **remote sensing** technologies can provide locational information at varying levels of resolution for virtually all parts of the United States. Remote sensing applications (both photographic and satellite imagery) can help the analyst reveal the past status of environmental resources or ecological processes, determine existing environmental conditions, and quantitatively or qualitatively assess possible future trends in the environment. Although remote sensing is a relatively recent technological development, aerial photography available for most areas of the United States since the 1930s or 1940s, and space-based photographs and satellite imagery have been collected since the 1960s. For example, aerial photography from 1960, 1981, and 1990 (Figure 5-2) show change in the condition of small mountainous tributary streams to the North Fork Hoh River in the Olympic Peninsula. The photo taken in 1960 shows undisturbed old growth Sitka spruce-hemlock forest. The photos of the same location taken in 1981 and 1990 show extensive timber harvest and soil erosion. Each patch of harvested timber was approved under individual logging permits over a 30-year period. As a result of the cumulative timber harvest, the area has experienced severe landsliding and erosion, causing sedimentation in salmon spawning and rearing areas in the Hoh River and in lower portions of the tributary streams.

The combination of remote sensing and GIS has facilitated the development of a suite of landscape-scale indicators of ecosystem status that hold promise for quantifying ecological variables and improving the measurement of cumulative effects (Hunsaker and Carpenter 1990; Noss 1990; O'Neill et al. 1988, 1994).

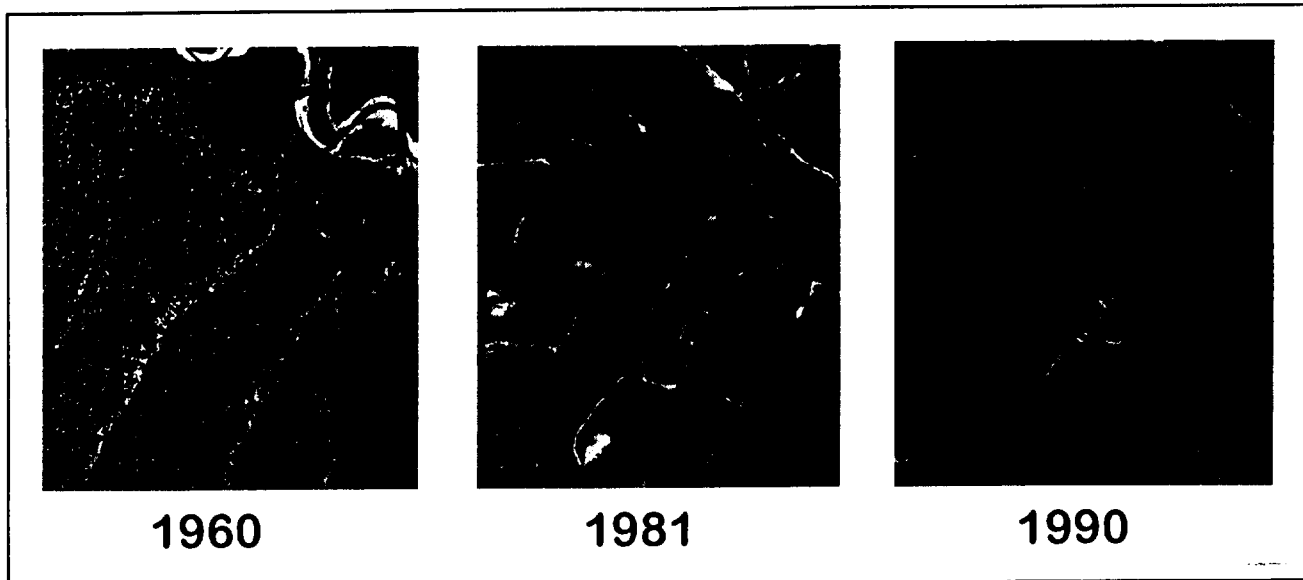

Figure 5-2. Deteriorating trend in watershed condition of the North Fork Hoh River, Washington as illustrated by a time-series of aerial photographs depicting cumulative loss of forest from individual timber sales (Dave Somers, The Tulalip Tribes, personal communication)

Table 5-3 summarizes the 11 important cumulative effects analysis methods discussed above. Appendix A provides standardized descriptions of these methods. Many cumulative effects analysis methods can be adapted for environmental or social impact assessment; the basic analytical frameworks and mathematical operations are often applicable to both social and environmental variables. Each of the 11 methods represents a general category that may contain more specific methods. When and where each method is appropriate for cumulative effects analysis depends on the following criteria:

- 1** Whether the method can assess
- effects of same and different nature
 - temporal change
 - spatial characteristics
 - structural/functional relationships
 - physical/biological/human interactions

- additive and synergistic interactions
- delayed effects
- persistence of impacts

- 2** Whether the method can
- quantify effects
 - synthesize effects
 - suggest alternatives
 - serve as a planning or decision-making tool
 - link with other methods, and

- 3** Whether the method is
- validated
 - flexible
 - reliable and repeatable.

Table 5-3. Primary and special methods for analyzing cumulative effects

Primary Methods	Description	Strengths	Weaknesses
<p>1. Questionnaires, Interviews, and Panels</p>	<p>Questionnaires, interviews, and panels are useful for gathering the wide range of information on multiple actions and resources needed to address cumulative effects. Brainstorming sessions, interviews with knowledgeable individuals, and group consensus building activities can help identify the important cumulative effects issues in the region.</p>	<ul style="list-style-type: none"> ▪ Flexible ▪ Can deal with subjective information 	<ul style="list-style-type: none"> ▪ Cannot quantify ▪ Comparison of alternatives is subjective
<p>2. Checklists</p>	<p>Checklists help identify potential cumulative effects by providing a list of common or likely effects and juxtaposing multiple actions and resources; - potentially dangerous for the analyst that uses them as a shortcut to thorough scoping and conceptualization of cumulative effects problems.</p>	<ul style="list-style-type: none"> ▪ Systematic ▪ Concise 	<ul style="list-style-type: none"> ▪ Can be inflexible ▪ Do not address interactions or cause-effect relationships
<p>3. Matrices</p>	<p>Matrices use the familiar tabular format to organize and quantify the interactions between human activities and resources of concern. Once even relatively complex numerical data are obtained, matrices are well-suited to combining the values in individual cells of the matrix (through matrix algebra) to evaluate the cumulative effects of multiple actions on individual resources, ecosystems, and human communities.</p>	<ul style="list-style-type: none"> ▪ Comprehensive presentation ▪ Comparison of alternatives ▪ Address multiple projects 	<ul style="list-style-type: none"> ▪ Do not address space or time ▪ Can be cumbersome ▪ Do not address cause-effect relationships
<p>4. Networks and System Diagrams</p>	<p>Networks and system diagrams are an excellent method for delineating the cause-and-effect relationships resulting in cumulative effects; they allow the user to analyze the multiple, subsidiary effects of various actions and trace indirect effects to resources that accumulate from direct effects on other resources.</p>	<ul style="list-style-type: none"> ▪ Facilitate conceptualization ▪ Address cause-effect relationships ▪ Identify indirect effects 	<ul style="list-style-type: none"> ▪ No likelihood for secondary effects ▪ Problem of comparable units ▪ Do not address space or time
<p>5. Modeling</p>	<p>Modeling is a powerful technique for quantifying the cause-and-effect relationships leading to cumulative effects, can take the form of mathematical equations describing cumulative processes such as soil erosion, or may constitute an expert system that computes the effect of various project scenarios based on a program of logical decisions.</p>	<ul style="list-style-type: none"> ▪ Can give unequivocal results ▪ Addresses cause-effect relationships ▪ Quantification ▪ Can integrate time and space 	<ul style="list-style-type: none"> ▪ Need a lot of data ▪ Can be expensive ▪ Intractable with many interactions
<p>6. Trends Analysis</p>	<p>Trends analysis assesses the status of a resource, ecosystem, and human community over time and usually results in a graphical projection of past or future conditions. Changes in the occurrence or intensity of stressors over the same time period can also be determined. Trends can help the analyst identify cumulative effects problems, establish appropriate environmental baselines, or project future cumulative effects.</p>	<ul style="list-style-type: none"> ▪ Addresses accumulation over time ▪ Problem identification ▪ Baseline determination 	<ul style="list-style-type: none"> ▪ Need a lot of data in relevant system ▪ Extrapolation of system thresholds is still largely subjective
<p>7. Overlay Mapping and GIS</p>	<p>Overlay mapping and geographic information systems (GIS) incorporate locational information, into cumulative effects analysis and help set the boundaries of the analysis, analyze landscape parameters, and identify areas where effects will be the greatest. Map overlays can be based on either the accumulation of stresses in certain areas or on the suitability of each land unit for development.</p>	<ul style="list-style-type: none"> ▪ Addresses spatial pattern and proximity of effects ▪ Effective visual presentation ▪ Can optimize development options 	<ul style="list-style-type: none"> ▪ Limited to effects based on location ▪ Do not explicitly address indirect effects ▪ Difficult to address magnitude of effects

Table 5-3. Continued			
Special Methods	Description	Strengths	Weaknesses
8. Carrying Capacity Analysis	Carrying capacity analysis identifies thresholds (as constraints on development) and provides mechanisms to monitor the incremental use of unused capacity. Carrying capacity in the ecological context is defined as the threshold of stress below which populations and ecosystem functions can be sustained. In the social context, the carrying capacity of a region is measured by the level of services (including ecological services) desired by the populace.	<ul style="list-style-type: none"> ▪ True measure of cumulative effects against threshold ▪ Addresses effects in system context ▪ Addresses time factors 	<ul style="list-style-type: none"> ▪ Rarely can measure capacity directly ▪ May be multiple thresholds ▪ Requisite regional data are often absent
9. Ecosystem Analysis	Ecosystem analysis explicitly addresses biodiversity and ecosystem sustainability. The ecosystem approach uses natural boundaries (such as watersheds and ecoregions) and applies new ecological indicators (such as indices of biotic integrity and landscape pattern). Ecosystem analysis entails the broad regional perspective and holistic thinking that are required for successful cumulative effects analysis.	<ul style="list-style-type: none"> ▪ Uses regional scale and full range of components and interactions ▪ Addresses space and time ▪ Addresses ecosystem sustainability 	<ul style="list-style-type: none"> ▪ Limited to natural systems ▪ Often requires species surrogates for system ▪ Data intensive ▪ Landscape indicators still under development
10. Economic Impact Analysis	Economic impact analysis is an important component of analyzing cumulative effects because the economic well-being of a local community depends on many different actions. The three primary steps in conducting an economic impact analysis are (1) establishing the region of influence, (2) modeling the economic effects, and (3) determining the significance of the effects. Economic models play an important role in these impact assessments and range from simple to sophisticated.	<ul style="list-style-type: none"> ▪ Addresses economic issues ▪ Models provide definitive, quantified results 	<ul style="list-style-type: none"> ▪ Utility and accuracy of results dependent on data quality and model assumptions ▪ Usually do not address nonmarket values
11. Social Impact Analysis	Social impact analysis addresses cumulative effects related to the sustainability of human communities by (1) focusing on key social variables such as population characteristics, community and institutional structures, political and social resources, individual and family changes, and community resources; and (2) projecting future effects using social analysis techniques such as linear trend projections, population multiplier methods, scenarios, expert testimony, and simulation modeling.	<ul style="list-style-type: none"> ▪ Addresses social issues ▪ Models provide definitive, quantified results 	<ul style="list-style-type: none"> ▪ Utility and accuracy of results dependent on data quality and model assumptions ▪ Social values are highly variable

REFERENCES

- Adamus, P.R., E.J. Clairain, Jr., R.D. Smith, and R.E. Young.** 1987. Wetland Evaluation Technique (WET). Vol. II. Methodology. U.S. Army Corps of Engineers Waterways Experiment Station, Vicksburg, MS. 178 pp.
- Allen, C.D.** 1994. Ecological perspective: Linking ecology, GIS, and remote sensing to ecosystem management. In Sample, V.A., ed. *Remote Sensing and GIS in Ecosystem Management*. Island Press, Washington, DC. pp. 111-139.
- Armour, C.L. and S.C. Williamson.** 1988. Guidance for Modeling Causes and Effects in Environmental Problem Solving. Biological Report 89(4). U.S. Fish and Wildlife Service, Fort Collins, CO.
- Bain, M.B., J.S. Irving, R.D. Olsen, E.A. Stull, and G.W. Witmer.** 1986. Cumulative Impact Assessment: Evaluating the Environmental Effects of Multiple Human Developments. Argonne National Laboratory, Argonne, IL. ANL/EES-TM-309
- Barber, M.C. ed.** 1994. Environmental Monitoring and Assessment Program: Indicator Development Strategy. U.S. Environmental Protection Agency, Washington, DC. EPA/620/R-94/022.
- Bardecki, M.J.** 1990. Coping with cumulative impacts: An assessment of legislative and administrative mechanisms. *Impact Assessment Bulletin* 8:319-344.
- Bastedo, J.D., J.G. Nelson, and J.B. Theberge.** 1984. Ecological approach to resource survey and planning for environmentally significant areas: The ABC methods. *Environmental Management* 8:125-134.
- Bedford, B.L. and E.M. Preston.** 1988. Developing the scientific basis for assessing cumulative effects of wetland loss and degradation on landscape functions: Status, perspectives, and prospects. *Environmental Management* 12:755.
- Bisset, R.** 1983. Methods for environmental impact analysis: Recent trends and future prospects. *Journal of Environmental Management* 11:27-43.
- Bronson, E.S., K. Sears, and W.M. Paterson.** 1991. A Perspective on Cumulative Effects Assessment. Report No. 91016 Environmental Studies and Assessments Department, Ontario Hydro, Toronto, Ontario. 32 pp.
- Brown, R.S. and K. Marshall.** 1993. Resource Guide to State Environmental Management. The Council of State Governments, Lexington, KY.
- Burris, R.K.** 1994. Cumulative Impact Assessment in the Environmental Impact Assessment Process. Masters Thesis, University of Oklahoma, Norman.
- Canter, L.W.** 1993. The role of environmental monitoring in responsible project management. *The Environmental Professional* 15:76-87.
- Canter, L.W.** 1994. Draft. Methods for Cumulative Effects Assessment. Environmental and Ground Water Institute, University of Oklahoma, Norman, OK.

- Canter, L.W. and J. Kamath.** 1995. Questionnaire checklist for cumulative impacts. *Environmental Impact Assessment Review* 15:311-339.
- Canters, K.J., C.P. den Herder, A.A. de Veer, P.W.M. Veelenturf, and R.W. de Waal.** 1991. Landscape-ecological mapping of the Netherlands. *Landscape Ecology* 5:145-162.
- Carpenter, R.A.** 1995a. Communicating environmental science uncertainties. *The Environmental Professional* 17:127-136.
- Carpenter, R.A.** 1995b. Risk assessment. *Impact Assessment* 13:153-187.
- Carpenter, R.A.** 1995c. Monitoring for adaptive management. Presented to DOE/CEQ Conference Commemorating the 25th Anniversary of NEPA. March 21-22, Tysons Corner, VA.
- Conover, S.K., W. Strong, T.E. Hickey, and F. Sander.** 1985. An envolving (sic) framework for environmental impact analysis. I. Methods. *Journal of Environmental Management* 21:343-358.
- Contant, C.K. and L. Ortolano.** 1985. Evaluating a cumulative impact assessment approach. *Water Resources Research* 21:1313-1318.
- Cooper, T.A.** 1995. Cumulative Impact Assessment Practice in the United States. Masters Thesis, University of Oklahoma, Norman.
- Dee, N., J.K. Baker, N.L. Drobny, K.M. Duke, I. Whitman, and D.C. Fahringer.** 1973. Environmental evaluation system for water resource planning. *Water Resources Research* 9:523-535.
- Eedy, W.** 1995. The use of GIS in environmental assessment. *Impact Assessment* 13:199-206.
- Emery, R.M.** 1986. Impact interaction potential: A basin-wide algorithm for assessing cumulative impacts from hydropower projects. *Journal of Environmental Management* 23:341-360.
- Federal Highway Administration (FHWA).** 1996. Community Impact Assessment: A Quick Reference for Transportation. FHWA, Office of Environmental and Planning, Washington, DC. FHWA-PD-96, HEP-30.
- Forman, R.T.T. and M. Godron.** 1986. *Landscape Ecology*. John Wiley & Sons, New York. 619 pp.
- Gosselink, J.G., G.P. Shafer, L.C. Lee, D.M. Burdick, D.L. Childers, N.C. Leibowitz, S.C. Hamilton, R. Boumans, D. Cushman, S. Fields, M. Koch, and J.M. Visser.** 1990. Landscape conservation in a forested wetland watershed: Can we manage cumulative impacts? *Bioscience* 40:588-600.
- General Accounting Office.** 1991. Coastal Pollution Environmental Impacts of Federal Activities Can Be Better Managed. Washington, D.C. RCED-91-85.
- Granholt, S.L., E. Gerstler, R.R. Everitt, D.P. Bernard, and E.C. Vlachos.** 1987. Issues, Methods, and Institutional Processes for Assessing Cumulative Biological Impacts. Prepared for Pacific Gas and Electric Company, San Ramon, CA. Report 009.5-87.5.
- Hayes, R.L.** 1989. Micro-HSI Master Model Library, Cover Type List and Variable Lexicon. Reference Manual v 2.1. U.S. Fish and Wildlife Service, Fort Collins, CO.
- Helliwell, D.R.** 1969. Valuation of wildlife resources. *Regional Studies* 3:41-47.
- Helliwell, D.R.** 1973. Priorities and values in nature conservation. *Journal of Environmental Management* 1:85-127.
- Hochberg, R.J., M.A. Friday, and C.F. Stroup.** 1993. Review of Technical Approaches for Cumulative Ecological Impact Assessment. Maryland Department of Natural Resources, Annapolis. PPRP-109.

- Horak, G.C., E.C. Vlachos, and E.W. Cline.** 1983. Methodological Guidance for Assessing Cumulative Impacts on Fish and Wildlife. Report to U.S. Fish and Wildlife Service. Dynamac Corporation, Fort Collins, CO.
- Hubbard, P.** 1990. Cumulative Effects Assessment and Regional Planning in Southern Ontario. Canadian Environmental Assessment Research Council, Hull, Quebec. 45 pp.
- Hunsaker, C.T. and D.E. Carpenter.** 1990. Environmental Monitoring and Assessment Program —Ecological Indicators. U. S. Environmental Protection Agency, Research Triangle Park, NC. EPA 600/3/-89/060.
- Hunsaker, C.T., R.L. Graham, G.W. Suter II, R.V. O'Neill, L.W. Barnthouse, and R.H. Gardner.** 1990. Assessing ecological risk on a regional scale. *Environmental Management* 14:325-332.
- Interagency Ecosystem Management Task Force (IEMTF).** 1995. The Ecosystem Approach: Healthy Ecosystems and Sustainable Economies, Vol. I Overview. Washington, DC.
- Irwin, F. and B. Rodes.** 1992. Making Decisions on Cumulative Environmental Impacts: A Conceptual Framework. World Wildlife Fund, Washington, DC. 54 pp.
- Jenkins, R.E.** 1988. Information management for the conservation of biodiversity. In Wilson, E.O., ed. *Biodiversity*. National Academy Press, Washington, D.C. pp 231-239.
- Johnston, C.A., N.E. Detenbeck, J.P. Bonde, and G.J. Niemi.** 1988. Geographic information systems for cumulative impact assessment. *American Society of Photogrammetry and Remote Sensing* 54(11):1609-1615.
- Karr, J.R.** 1991. Biological integrity: A long-neglected aspect of water resource management. *Ecological Applications* 1:66-84.
- Karr, J.R., K.D. Fausch, P.L. Angermeier, P.R. Yant, and I.J. Schlosser.** 1986. Assessing Biological Integrity in Running Waters: A Method and Its Rationale. Illinois Natural History Survey Special Publication 5, Champaign, IL.
- Lackawanna County Regional Planning Commission.** 1996. Lackawanna Valley Corridor Plan. Scranton, PA.
- Lane, P.A. and R.R. Wallace.** 1988. A User's Guide to Cumulative Effects Assessment in Canada. Canadian Environmental Assessment Research Council, Ottawa, Ontario.
- Larsen, D.P. and S.J. Christie.** 1993. EMAP-Surface Waters 1991 Pilot Report. U.S. Environmental Protection Agency, Corvallis, OR. EPA/620/R-93/003.
- Leibowitz, S.G., B. Abbruzzese, P. Adamus, L. Hughes, and J. Irish.** 1992. A Synoptic Approach to Cumulative Impact Assessment—A Proposed Methodology. U.S. Environmental Protection Agency, Corvallis, OR. EPA/600/R-92/167.
- Lewis, T.E. and B.L. Conkling, eds.** 1994. Forest Health Monitoring Southeast Loblolly/ Shortleaf Pine Demonstration Interim Report. U.S. Environmental Protection Agency, Washington, DC. EPA/620/R-94/006.
- Marlatt, R.M., T.A. Hale, and R.G. Sullivan.** 1993. Video simulation as a part of Army environmental decision-making: Observations from Camp Shelby, Mississippi. *Environmental Impact Assessment Review* 13:75-88.
- McCabe, G., C. Orians, C. Clavate, and K. Branch.** 1991. Driving variables that impact environmental quality. Battelle Pacific Northwest National Laboratory, Richland, WA.
- McCold, L. and J. Holman.** 1995. Cumulative impacts in environmental assessments: How well are they considered. *The Environmental Professional* 17:2-8

McHarg, I. 1969. *Design with Nature*. Natural History Press, New York, NY. 197 pp.

Messer, J.J., R.A. Linthurst, and W.S. Overton. 1991. An EPA program for monitoring ecological status and trends. *Environmental Management* 17:67-78.

National Academy of Sciences. 1993. *A Biological Survey for the Nation*. National Academy Press, Washington, DC.

National Park Service. 1990. Final Environmental Impact Statement. Mining in Yukon-Charley Rivers National Preserve, Alaska. Cumulative Impacts of Mining. Volume 1. Anchorage, AK.

National Performance Review. 1994. *Creating a Government that Works Better and Costs Less*. Washington, D.C. September.

National Research Council (NRC). 1986. The special problem of cumulative effects. In Committee on the Applications of Ecological Theory to Environmental Problems. *Ecological Knowledge and Problem Solving: Concepts are Case Studies*. National Academy Press, Washington, D.C. pp. 93-103.

Nestler, J. 1992. Cumulative impact assessment in wetlands. *Wetlands Research Program Bulletin* 1:1-8. U.S. Army Corps of Engineers, Vicksburg, MS.

Noss, R.F. 1990. Indicators for monitoring biodiversity: A hierarchical approach. *Conservation Biology* 4:355-364.

Odum, W.E. 1982. Environmental degradation and the tyranny of small decisions. *Bioscience* 33:728-729.

O'Neill, R.V., J.R. Krummel, R.H. Gardner, G. Sugihara, B. Jackson, D.L. DeAngelis, B.T. Milne, M.G. Turner, B. Zygmunt, S.W. Christensen, V.H. Dale, and R.I. Graham. 1988. Indices of landscape pattern. *Landscape Ecology* 1:153-162.

O'Neill, R.V., K.B. Jones, K.H. Riitters, J.D. Wickham, and I.A. Goodman. 1994. Landscape Monitoring and Assessment Research Plan. U.S. Environmental Protection Agency, Las Vegas, NV. EPA/620/R-94/009.

Overton, W.S., D. White, and D.L. Stevens. 1990. Design Report for EMAP (Environmental Monitoring and Assessment Program). U.S. Environmental Protection Agency, Corvallis, OR. EPA/600/391/053.

Patterson, N.J. and T.H. Whillans. 1984. Human interference with natural water level regimes in the context of other cultural stresses on Great Lakes wetlands. In H.H. Prince and F.M. D'Itri, eds. *Coastal Wetlands*. Lewis Publishers, Inc., Chelsea, MI.

Peterson, E.B., Y.H. Chan, N.M. Peterson, G.A. Constable, R.B. Caton, C.S. Davis, R.R. Wallace, and G.A. Yarranton. 1987. *Cumulative Effects Assessment in Canada: An Agenda for Action and Research*. Canadian Environmental Assessment Research Council, Hull, Quebec.

President's Council on Sustainable Development. 1996. *Sustainable America: A New Consensus for Prosperity, Opportunity, and a Healthy Environment in the Future*, Washington, DC. 186 pp.

Preston, E.M., and B.L. Bedford. 1988. Evaluating cumulative effects on wetland functions: A conceptual overview and generic framework. *Environmental Management* 12:565-583.

- Radbruch-Hall, D.H., K. Edwards, and R.M. Batson.** 1987. Experimental Engineering-Geologic and Environmental-geologic Maps of the Conterminous United States. Bulletin 1610. U.S. Geological Survey, Reston, VA.
- Ranasinghe, J.A., S.B. Weisberg, J. Gerritsen, and D.M. Dauer.** 1994. Assessment of Chesapeake Bay Benthic Macroinvertebrate Resource Condition in Relation to Water Quality and Watershed Stressors. Prepared for The Governor's Council on Chesapeake Bay Research Fund and Maryland Department of Natural Resources, Annapolis, MD.
- Reid, W.V., J.A. McNeely, D.B. Tunstall, and D. Bryant.** 1991. Indicators of Biodiversity Conservation. World Resources Institute, Washington, D.C.
- Risser, P., J.R. Karr, and R.T.T. Forman.** 1984. Landscape Ecology: Directions and Approaches. Champaign: Illinois Natural History Survey, Special Publication 2.
- Schamberger, M., A.H. Farmer, and J.W. Terrell.** 1982. Habitat Suitability Index Models: Introduction. U.S. Fish and Wildlife Service, Washington, D.C.
- Southerland, M.T. and J.B. Stribling.** 1995. Status of biological criteria development and implementation. In Davis, W. and T. Simon, eds. *Biological Assessment and Criteria: Tools for Water Resources Planning and Decision Making*. Lewis Publishers, Inc, Chelsea, MI. pp. 79-94.
- Southerland, M.T. and S.B. Weisberg.** 1995. Maryland Biological Stream Survey: The 1995 Workshop Summary. Chesapeake Bay Research and Monitoring Division, Maryland Department of Natural Resources, Annapolis. CBRM-BA-95-2.
- Spaling, H.** 1995. Cumulative effects assessment. *Impact Assessment* 12:231-251.
- Spaling, H. and B. Smit.** 1993. Cumulative environmental change: conceptual frameworks, evaluation approaches, and institutional Perspectives. *Environmental Management* 17:587-600.
- Stakhiv, E.Z.** 1988. An evaluation paradigm for cumulative impact analysis. *Environmental Management* 12:725-748.
- Stakhiv, E.Z.** 1991. A cumulative impact analysis framework for the US Army Corps of Engineers regulatory program. Draft report (February 1991). Institute for Water Resources, US Army Corps of Engineers, Fort Belvoir, VA. 282 pp.
- Stowell, R., Espinosa, T.C. Bjornn, W.S. Platts, D.C. Burns, and J.S. Irving.** 1983. Guide for Predicting Salmonid Response to Sediment Yields in Idaho Batholith Watersheds. U.S. Forest Service, Northern and Intermountain Regions.
- Stull, E.A., K.E. LaGory, and W.S. Vinikour.** 1987. Methodologies for Assessing the Cumulative Environmental Effects of Hydroelectric Development on Fish and Wildlife in the Columbia River Basin Volume 1: Recommendations. Final report to Bonneville Power Administration, Portland, OR. DOE/BP-19461-3.
- Summers, J.K., J.M. Macauley, V.D. Engle, G.T. Brooks, P.T. Heitmuller, A.M. Adams.** 1993. Louisianan Province Demonstration Report: EMAP —Estuaries, 1991. U.S. Environmental Protection Agency, Gulf Breeze, FL. EPA/620/R-94/001
- Suter, G.W. II.** 1993. *Ecological Risk Assessment*. Lewis Publishers, Boca Raton, FL.
- Thornton, K. W., G. E. Saul, and D. E. Hyatt.** 1994. Environmental Monitoring and Assessment Program Assessment Framework. U.S. Environmental Protection Agency, Research Triangle Park, NC. EPA/620/R-94/016.

U.S. Army Corps of Engineers (USACE). 1980. *A Habitat Evaluation System for Water Resource Planning*. U.S. Army Corps of Engineers, Vicksburg, MS. 88 pp.

U.S. Army Corps of Engineers (USACE), Washington Department of Ecology, and Port of Seattle. 1994. *Southwest Harbor Cleanup and Redevelopment Project: Joint Federal/state Draft Environmental Impact Statement*. Seattle, WA.

U.S. Bureau of Land Management (BLM). 1990. *Final Environmental Impact Statement*. Castle Mountain Project, San Bernadino County, California. Needles, CA.

U.S. Environmental Protection Agency. 1992. *Framework for Ecological Risk Assessment*. Risk Assessment Forum, Washington, DC. EPA 630/R-92-001.

U.S. Environmental Protection Agency. 1993. *A Guidebook to Comparing Risks and Setting Environmental Priorities*. Washington, DC. EPA 230-B-93-003.

U.S. Forest Service. 1993. *Pacific Yew Final Environmental Impact Statement*. USDA, Forest Service, Pacific Northwest Regional Office, Portland, OR.

U.S. Fish and Wildlife Service. 1980. *Habitat Evaluation Procedures*. ESM 102. US Fish and Wildlife Service, Division of Ecological Services. Washington, D.C.

Vestal, B., A. Rieser M. Ludwig, J. Kurland, C. Collins, and J. Ortiz. 1995. *Methodologies and Mechanisms for Management of Cumulative Coastal Environmental Impacts*. Part I—Synthesis, with Annotated Bibliography; Part II—Development and Application of a Cumulative Impacts Assessment Protocol. NOAA Coastal Ocean Program Decision Analysis Series No. 6. NOAA Coastal Ocean Office, Silver Spring, MD.

Weisberg, S.B., J.B. Frithsen, A.F. Holland, J.F. Paul, K.J. Scott, J.K. Summers, H.T. Wilson, R. Valente, D.G. Heimbuch, J. Gerritsen, S. C Schimmel, and R.W. Latimer. 1993. *EMAP-Estuaries Virginian Province 1990 Demonstration Project Report*. USEPA, Environmental Research Laboratory, Narragansett, RI. EPA 600/R-92/100.

Westman, W.E. 1985. *Ecology, Impact Assessment, and Environmental Planning*. Wiley-Interscience, New York, NY.

Williamson, S.C. 1993. *Cumulative impacts assessment and management planning: Lessons learned to date*. In Hildebrand, S.G. and J.B. Cannon, eds. *Environmental Analysis: The NEPA Experience*. Lewis Publishers, Boca Raton, FL. pp 391-407.

Williamson, S.C. and K. Hamilton. 1989. *Annotated Bibliography of Ecological Cumulative Impacts Assessment*. U.S. Fish and Wildlife Service Biological Report 89(11). National Ecology Research Center, Fort Collins, CO.

Witmer, G., J.S. Irving, and M. Bain. 1985. *A Review and Evaluation of Cumulative Impact Assessment Techniques and Methodologies*. Prepared by Argonne National Laboratory for Bonneville Power Administration.

World Commission on Environment and Development. 1987. *Our Common Future*. Oxford University Press, UK.

APPENDIX A

SUMMARIES OF CUMULATIVE EFFECTS ANALYSIS METHODS

Visited on 10/23/2018

METHODS

1

QUESTIONS, INTERVIEWS, AND PANELS

Questionnaires, interviews, and panels are important information gathering techniques for analyzing cumulative effects. Such techniques are especially valuable to the analyst, because they *collect information on the wide range of actions and effects needed to address cumulative problems*. The analyst will often use brainstorming sessions, interviews with knowledgeable individuals, and group consensus building activities to identify the important cumulative effects issues in the region.

Questionnaires, interviews, and panels are applicable to both social and environmental effects and are used primarily in the scoping process. They are often the principal method for identifying potential efforts and can be used to help characterize spatial and cause-and-effect relationships. Rather than simply collecting data, these techniques can be used for "strategizing" (i.e., prioritizing issues and defining the scope of the study).

The choice of information gathering techniques draws upon the experience and professional judgement of the analysts. Simple brainstorming of experts and other interested parties can be an effective technique for

identifying potential cumulative effects problems. Information gathering can be expanded to include structured interviews with key opinion leaders, indigenous peoples, and technical experts. These activities are essential components of the scoping process and, in many cases, are sufficient for qualitative analysis.

A common feature of information gathering and strategizing is the use of a multi-disciplinary panel of experts. These panels can bring consensus to subjective judgements and are useful for designing the assessment method, evaluating the significance of effects, and comparing alternatives. The Delphi method (Linstone and Turoff 1975) provides a structured process for producing expert consensus and is applicable to groups of various compositions. Fuzzy set models provide another means of structuring subjective evaluations of cumulative effects issues (Harris et al. 1994; Wegner and Reng 1987). Panels or other group-decision methods often use evaluative techniques to score or rank effects during the decisionmaking process. In this way, panels can be used to estimate the importance of cumulative effects even though they are necessarily subjective and qualitative (Stull et al. 1987).

METHODS

1

EXAMPLES:

Information gathering is essential to all environmental impact assessment and can become especially involved when scoping for cumulative effects in an EIS. Primarily, the analyst will use questionnaires, interviews, and panels to build a comprehensive list of environmental problems that could accumulate. During preparation of an EIS on the Castle Mountain open heap leach gold mine project, the U.S. Bureau of Land Management (1990) compiled a wide range of information into a list of activities that, combined with the proposed action, might produce cumulative effects (Chapter 3, Table 3-1). For each of 26 individual activities, anticipated cumulative effects were identified for each of 12 resource issues. The status (existing or proposed) of these additional activities and the primary geographical location of effects were also listed.

The analyst will also use these information gathering techniques to help develop a community vision for the region when the cumulative effect of a suite of actions will restore resources. The Restoration Plan for the Exxon Valdez Oil Spill in Alaska involved identifying many individual restoration options that, when combined as an alternative, would have the cumulative beneficial effect of mitigating natural resource damages resulting from the spill. The Restoration Plan required an extremely high level of coordination among federal and state agencies, as well as commercial fishermen, local businesses, and Native American communities. The Restoration Team had the formidable task of determining whether the cumulative effect of a set of restoration

options (an alternative) would meet the public's expectations for restoration of resources. To accomplish this, a scientific conference and many public meetings were held, producing a "Restoration Framework" that served as a scoping document under NEPA (EVOS Trustee Council 1992, 1993). In addition, a questionnaire was distributed to the public along with a summary of the draft Restoration Plan (EVOS Restoration Office 1993) as a means of soliciting public comment on the critical issues addressed by the Restoration Plan.

References

- Exxon Valdez Oil Spill (EVOS) Restoration Office. 1993. Exxon Valdez Oil Spill Restoration Plan. Summary of Alternatives for Public Comment. Anchorage, AK. April.
- Exxon Valdez Oil Spill (EVOS) Trustee Council. 1992. Exxon Valdez Oil Spill Restoration, Volume I: Restoration Framework. Anchorage, AK. April.
- Exxon Valdez Oil Spill (EVOS) Trustee Council. 1993. Exxon Valdez Oil Spill Symposium. Anchorage, AK. February.
- Harris, H.J., R.D. Wenger, V.A. Harris, and D.S. DeValut. 1994. A method for assessing environmental risks: A case study of Green Bay, Lake Michigan. *Environmental Management* 18(2):295-306.
- Linstone, H.A. and M. Turoff, eds. 1975. *The Delphi Methods: Techniques and Applications*. Addison-Wesley Publishing Co., Reading, MA.

METHODS

Stull, E.A., K.E. LaGory, and W.S. Vinikour. 1987. Methodologies for assessing the cumulative environmental effects of hydroelectric development on fish and wildlife in the Columbia River Basin - Volume 1: Recommendations. DOE/BP-19461-3. Final report to Bonneville Power Administration, Portland, OR.

U.S. Bureau of Land Management. 1990. Final Environmental Impact Statement. Castle Mountain Project, San Bernadino County, California. Needles, CA.

Wenger R. and Y. Reng. 1987. Two fuzzy set models for comprehensive environmental decisionmaking. *Journal of Environmental Management* 25:167-180.

METHODS

2

CHECKLISTS

Checklists can help the analyst identify potential environmental effects by providing a list of common or likely effects. Checklists are especially valuable for analyzing cumulative effects because they *provide a format for juxtaposing multiple actions and resources in a way that highlights potential cumulative effects*. Checklists are potentially dangerous for the analyst who uses them as a shortcut to thorough scoping.

The strength of checklists is that they structure the analysis and reduce the likelihood that major effects will be overlooked; however, checklists are incomplete, they may cause important effects to be omitted. Because of the standard checklist format, checklists are more repeatable than ad hoc methods. They also provide a means of concisely presenting effects. At the same time, the simplicity of the checklist format has disadvantages. A checklist may be either an incomplete compilation of effects or a huge, unwieldy list with many irrelevant

effects. In an attempt to be comprehensive, the checklist may also lead to "double counting" the same effect under different headings.

Many of these disadvantages are avoided by developing checklists for specific kinds of projects. Checklists can also be simplified by organizing potential effects into separate lists or hierarchical categories for each resource, ecosystem, and human community of concern. To address cumulative effects, checklists need to incorporate all of the activities associated with the proposed action and other past, present, and future actions affecting the resources. A promising approach is to use project-specific checklists (for each relevant past, present, and future action) to identify and quantify effects on resources and then transfer these effects to a cumulative checklist or interaction matrix (see Method 3). Two or more effects on a single resource indicate a potential cumulative effect; weighted effects can be summed to indicate the magnitude of the effect.

METHODS

2 EXAMPLES:

Specific checklists have been developed for many different classes of actions (e.g., housing projects, sewage treatment facilities, power plants, highways, airports). Several federal agencies have standard checklists for preparing EISs or EAs (e.g., U.S. DOE 1994). The California Department of Transportation (1993) has developed a checklist of 56 questions that must be answered for each state highway project. Question 55 specifically addresses cumulative effects:

Does the project have environmental effects which are individually limited, but cumulatively considerable? Cumulatively considerable means that the incremental effects of an individual project are considerable when viewed in connection with the effects of past projects, the effects of other current projects, and the effects of probable future projects. It includes the effects of other projects which interact with this project and, together, are considerable.

This kind of "simple" questionnaire checklist acts merely as a reminder to the analyst and does not include supplemental information about the likely kinds of effects that may arise. Canter and Kamath (1995) have developed a comprehensive, yet generic, questionnaire checklist that addresses the cumulative effects

of projects. "Descriptive" checklists expand on the checklist concept by including information on measuring and predicting effects (Canter 1996). A more elaborate descriptive checklist is the environmental impact computer system developed by the U.S. Army Construction Engineering Laboratory (Lee et al. 1974). This system identifies potential environmental effects from 9 functional areas of Army activities on 11 broad environmental categories (Jain and Kumar 1973). This computer system can produce checklists of potential effects arising from up to 2,000 Army activities on 1,000 environmental factors. The organization of activities and resources in the same table constitutes an interaction matrix as originally devised by Leopold and others (1971).

Checklists can also be modified to include qualitative terms for each identified effect, such as "adverse" or "beneficial," "short-term" or "long-term," and "no effect" or "significant effect." The hypothetical cumulative checklist in Table A-1 uses a qualitative symbol in place of the usual checkmark next to each potential effect on the list. In this example, the cumulative effects column reflects the number or magnitude of cumulative effects identified for that resource row. More sophisticated uses of this tabular approach are discussed in the matrices section that follows.

METHODS

Potential Impact Area	Proposed Action			Past Actions	Other Present Actions	Future Actions	Cumulative Impact
	Construction	Operation	Mitigation				
Topography and Soils	**			*			**
Water Quality	**	*	+	*	*	*	***
Air Quality		**		*			**
Aquatic Resources	**	**	+	*		*	**
Terrestrial Resources	*	*		*			**
Land Use	*	***		*		*	***
Aesthetics	**	***	+	*			**
Public Services	*	+				+	+
Community Structure		*			*		*
Others							

KEY: * low adverse effect ** moderate adverse effect *** high adverse effect
 + beneficial effect □ no effect

References

California Department of Transportation (Caltrans). 1993. Environmental Significance Checklist, Caltrans Contract No. 08E425. Project Report and Environmental Document for Interstate 215 from I-10 to SR 30. 9 pp.

Canter, L.W. 1996. *Environmental Impact Assessment. Second Edition.* McGraw-Hill, New York.

Canter, L.W. and J. Kamath. 1995. Questionnaire checklist for cumulative impacts. *Environmental Impact Assessment Review.* 15:311-339.

Jain, R.K. and R. Kumar. 1973. Environmental impact assessment study for Army military programs. Technical Report. D-13, U.S. Army Construction Engineering Laboratory, Champaign, IL.

Lee, E.Y.S., et al. 1974. Environmental impact

assessment computer system. Technical Report. E-37, U.S. Army Construction Engineering Laboratory, Champaign, IL.

Leopold, L.B., F.E. Clarke, B.B. Hanshaw, and J.R. Balsley. 1971. A Procedure for Evaluating Environmental Impact. Circular 645. U.S. Geological Survey. 13 pp.

U.S. Department of Energy (DOE). 1994. Environmental Assessment Checklist. Office of NEPA Oversight, U.S. DOE, Washington, DC.

METHODS

3 MATRICES

Matrices are two-dimensional checklists that attempt to quantify the interactions between human activities and resources or ecosystems of concern. They were designed to assess the magnitude and importance of individual interactions between activities and resources (Leopold et al. 1971) but have been extended to consider the cumulative effects of multiple actions on resources (Bain et al. 1986; Stull et al. 1987; LaGory et al. 1993).

Matrices alone cannot quantify effects, but they are a useful means of presenting and manipulating quantitative results of modeling, mapping, and subjective techniques. Once even relatively complex numerical data are obtained, matrices are well-suited to *combining the values in individual cells in the matrix (through matrix algebra) to evaluate the cumulative effects of multiple actions on individual resources, ecosystems, and human communities*. Matrices have the advantage of being mathematically straightforward and readily amenable to interpretation because of their familiar tabular format. Matrices are commonly used in social science research and have the potential for increased application in social and economic analyses.

The values entered in a matrix can take one of several forms. The analyst may elect to simply note the presence or absence of an effect (i.e., a binary entry). This has the benefit of being straightforward and readily understandable; however, it fails to note the magnitude of

effects on various resources and does not allow the user to value resources differentially (e.g., through the use of numeric weights). Thus, a binary approach does not facilitate analyzing the cumulative effects on a resource, where the activities have consequences of varying degrees.

Analysts may instead choose to score effects based on factors such as magnitude, importance, duration, probability of occurrence, or feasibility of mitigation. The value entered may reflect some measurable value (e.g., soil loss may be expressed in tons/acre/ year), or it may reflect some relative ranking of the effect. Although complex weighting schemes allow the user to rank resource effects, the results may be difficult for others to understand, and the weighting schemes can be highly subjective. When using weighting schemes, analysts should enunciate the ranking criteria and consider whether it is scientifically reasonable to attempt a numeric comparison of cumulative effects on different resources.

The matrix concept can be extended to include stepped matrices that display resources against other resources (Canter 1996). Stepped matrices address secondary and tertiary effects of initiating actions and facilitate tracing effects through the environment. For example, action 1 causes changes in resource A which causes further changes in resource B. Stepped matrices are an intermediate method between simple matrices and networks and system diagrams (see Method 4).

METHODS

3 EXAMPLES:

Matrices were first formally proposed for environmental impact assessment by the U.S. Geological Survey (Leopold et al. 1971). Since that time a number of matrix methods have been proposed for analyzing cumulative effects. One such methodology is the Cluster Impact Assessment Procedure (CIAP) developed by the Federal Energy Regulatory Commission in the mid-1980s (FERC 1985, 1986a; Russo 1985). The methodology was developed specifically for use in assessing the cumulative effects of small hydroelectric facilities within single watersheds. The CIAP uses a matrix for each resource (e.g., salmon) consisting of relative effect ratings (on a scale from 1 to 5) arranged by project and resource components (e.g., for salmon, spawning habitat, migration). Each resource matrix table contains a summary column that represents the sum of effect ratings across components for each project (Figure A-1). An overall summary table is then developed that presents the effects of each project on all resources analyzed.

The CIAP does not incorporate or consider the possibility of synergistic interactions among projects that could result in nonadditive effects on resources; the effects of individual projects are simply added together to determine cumulative effects. This short-coming led to modification of the methodology to include interaction effects. With these modifications, cumulative

effects are viewed as being equivalent to the sum of the effects of individual projects plus any interaction between pairs of projects. Modified CIAP procedures include the approach used in the Salmon River and Snohomish River EISs for hydroelectric development in those basins (FERC 1986b, 1987; Irving and Bain 1993). Other matrix methodologies that incorporate interaction effects have been proposed (Bain et al. 1986; Stull et al. 1987; LaGory et al. 1993). Each represents a further development of the approach with an attempt to more accurately quantify cumulative impacts; consequently, each succeeding methodology attains additional complexity.

The Integrated Tabular Methodology (Stull et al. 1987; LaGory et al. 1993) uses the same matrix approach as Bain et al. (1986) but involves a systematic (albeit relatively complex) method of quantifying and developing interaction coefficients. To determine interaction coefficients, this method requires identification of the impact zones for all projects being evaluated as well as knowledge of the response of resources to environmental change. The methodology is designed to be flexible and can use a wide variety of data and models. For example, the methodology can use evaluative criteria such as effect ratings, habitat suitability indices (USFWS 1980; Bovee 1982), or quantitative population models.

METHODS

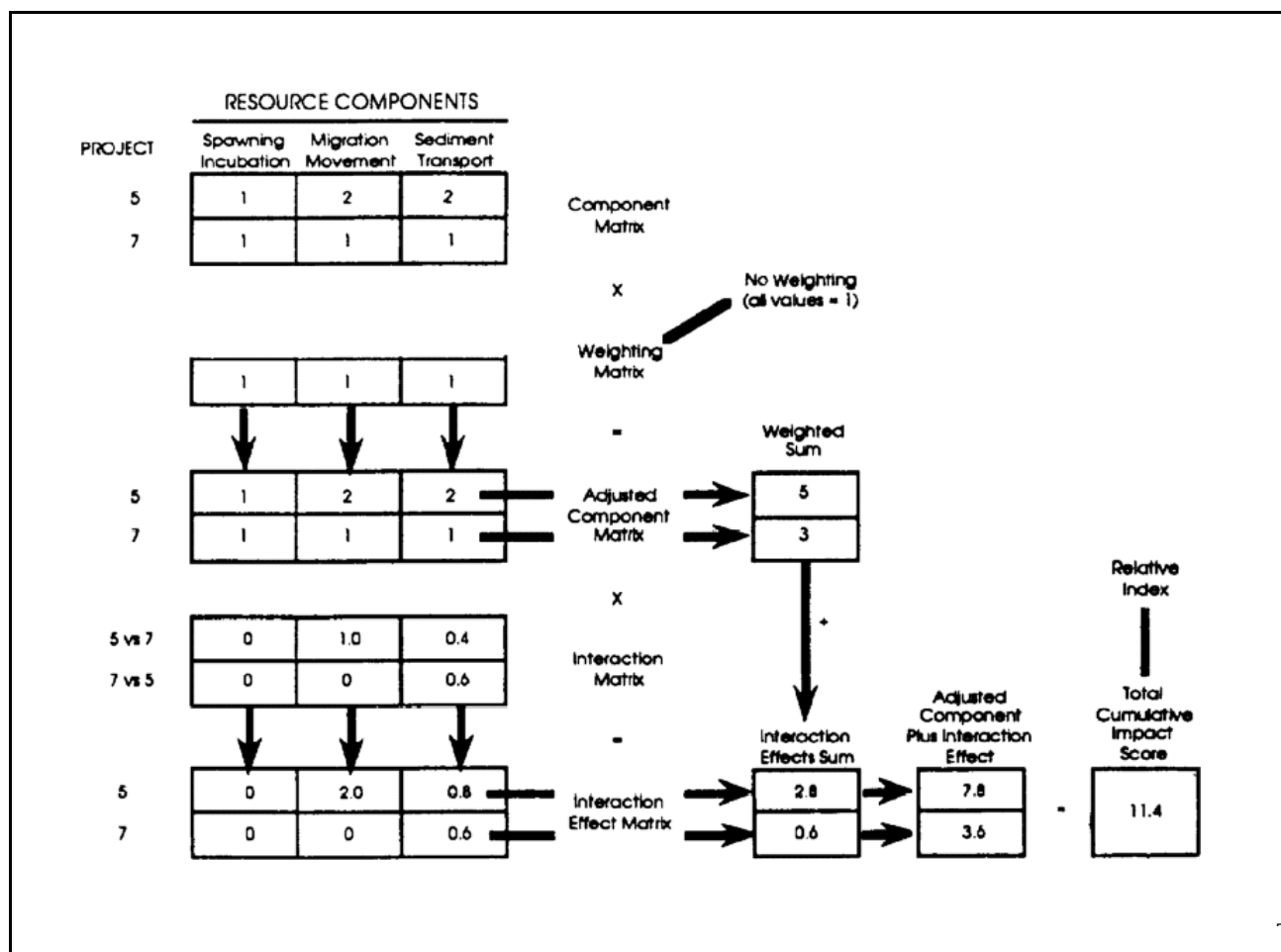

Figure A-1. Example of cumulative impact computations for a target resource with three resource components and two projects (FERC 1987).

References

Bain, M.B., J.S. Irving, R.D. Olsen, E.A. Stull, and G.W. Witmer. 1986. Cumulative impact assessment: evaluating the environmental effects of multiple human developments. ANL/EES-TM-309. Argonne National Laboratory, Argonne, IL.

Bovee, K.D. 1982. A guide to stream habitat analysis using the instream flow incremental methodology. Instream Flow Information Paper 12. FWS/OBS-82/26. U.S. Fish and Wildlife Service, Western Energy and Land Use Team, Fort Collins, CO.

Canter, L.W. 1996. *Environmental Impact Assessment, Second Edition*. McGraw-Hill, New York.

Federal Energy Regulatory Commission (FERC). 1985. Procedures for assessing hydropower projects clustered in river basins: request for comments. *Federal Register* 50:3385-3403.

Federal Energy Regulatory Commission (FERC). 1986a. Owens River Basin, seven hydroelectric projects, California. Federal Energy Regulatory Commission, Washington, D.C. FERC/DEIS-0041.

METHODS

Federal Energy Regulatory Commission (FERC). 1986b. Snohomish River Basin, seven hydroelectric projects, Washington. Federal Energy Regulatory Commission, Washington, D.C. FERC/FEIS-0042.

Federal Energy Regulatory Commission (FERC). 1987. Salmon River Basin, fifteen hydroelectric projects, Idaho. Federal Energy Regulatory Commission, Washington, D.C. FERC/FEIS-0044.

Irving, J.S. and M.B. Bain. 1993. Assessing Cumulative Impact on Fish and Wildlife in the Salmon River Basin, Idaho. In S.G. Hildebrand and J.B. Cannon. eds. *Environmental Analysis: The NEPA Experience*. Lewis Publishers, Boca Raton, FL. pp. 357-372.

LaGory, K.E., E.A. Stull, and W.S. Vinikour. 1993. Proposed methodology to assess cumulative impacts of hydroelectric development in the Columbia River Basin. Pp. 408-423 in S.G. Hildebrand and J.B. Cannon, eds. *Environmental Analysis: the NEPA Experience*. Lewis Publishers, Boca Raton, FL.

Leopold, L.B., F.E. Clarke, B.B. Hanshaw, and J.R. Balsley. 1971. A Procedure for Evaluating Environmental Impact. Circular 645. U.S. Geological Survey. 13 pp.

Russo, T.N. 1985. Perspectives on analyzing impacts related to multiple hydroelectric development. Pp 346-350 in F.W. Olson, R.G. White, and R.H. Hamre (eds), *Proceedings of the Symposium on Small Hydropower and Fisheries*, American Fisheries Society, Bethesda, MD.

Stull, E.A., K.E. LaGory, and W.S. Vinikour. 1987. Methodologies for assessing the cumulative environmental effects of hydroelectric development on fish and wildlife in the Columbia River Basin – Volume 2: Example and procedural guidelines. Final report to Bonneville Power Administration, Portland, OR. DOE/BP-19461-4.

U.S. Fish and Wildlife Service. 1980. Habitat evaluation procedures. ESM 102. U.S. Fish and Wildlife Service, Division of Ecological Services, Washington, D.C.

METHODS

4

NETWORKS AND SYSTEM DIAGRAMS

Networks and system diagrams relate the components of an environmental or social system in a chain (network) or web (loop or system diagram) of causality and allow the user to trace cause and effect through a series of potential links. They allow the user to analyze the multiple, subsidiary effects of various actions and trace indirect effects on resources stemming from direct effects on other resources. In this way, the accumulation of multiple effects on individual resources, ecosystems, and human communities can be determined. *Networks and system diagrams are often the analyst's best method for identifying the cause-and-effect relationships that result in cumulative effects.*

Networks, loops, and system diagrams improve on the stepped matrix approach to illustrating the relationship among actions, effects, and environmental or socioeconomic conditions by using component boxes (or symbols) and linkage arrows (denoting processes). Networks and system diagrams concisely illustrate interactions among variables and secondary effects. Cumulative effects are identified whenever multiple sources affect the same resource, or when multiple effects of the same source affect a resource (via indirect pathways through other resource components). When quantitative measures are included, effects and their interactions can be evaluated using a common unit of measurement (usually energy flow). The use of a common scale distinguishes networks and system diagrams from other cumulative effects analysis methods but requires evaluating different classes of effects separately (e.g., ecological versus social impacts).

By definition, network analysis proceeds in only one direction (forward), whereas loops or system diagrams allow feedback of information output by one part of the system to any other part of the system. Networks also assume a strict hierarchical linkage among system variables and are thus not capable of showing all relationships among variables. In contrast, system diagrams are specifically designed to illustrate the interrelationships (and process pathways) among all components and thus are more realistic. The lack of an appropriate unit of measure for all system compartments can limit the analyst's ability to quantify system diagrams, but some success has been obtained by using the flow of water or energy flow as common units of measure (Gilliland and Risser 1977).

Expert systems can be used to implement network analysis. Expert systems are simply sets of logical rules that mirror the analysis process of an expert in some field. To identify cumulative effects, an expert system would (1) query the analyst about additional activities that might affect the resource in question and (2) carry the predicted effects through known causal links to reveal additional secondary effects on each resource. The line of questioning will take different courses, depending on the user's answers to questions along the way. The program used to work its way through the questions and answers is called an inference engine.

METHODS

4 EXAMPLES:

Since the introduction of network analysis for impact assessment by Sorensen (1971), networks and systems diagrams have been useful for describing cause-and-effect relationships in both natural and human-dominated systems. Figure A-2 illustrates how cumulative effects on socioeconomic conditions can be identified. The figure (modified from Rau and Wooten 1985) shows how the removal of both homes and businesses (following freeway construction) cumulatively results in an increase in property tax rate at the tetryary level of effects. A comprehensive network (Figure A-3) illustrating all causes, perturbations, primary effects, and secondary effects related to coastal zone development was prepared for the

Australian (Commonwealth) Environmental Protection Agency (1994).

An example of the case of a single activity resulting in cumulative effects on a single resource through indirect effects is illustrated in Figure A-4 (Bisset 1983). This system diagram shows damage to fish spawning resulting from aerial application of herbicides through five different pathways resulting in low dissolved oxygen and high sediment stress. Low dissolved oxygen is caused by decreased plankton growth and increased oxygen consumption from debris pollution and erosion; increased sediment is also caused by debris pollution and increased erosion following the loss of riparian vegetation.

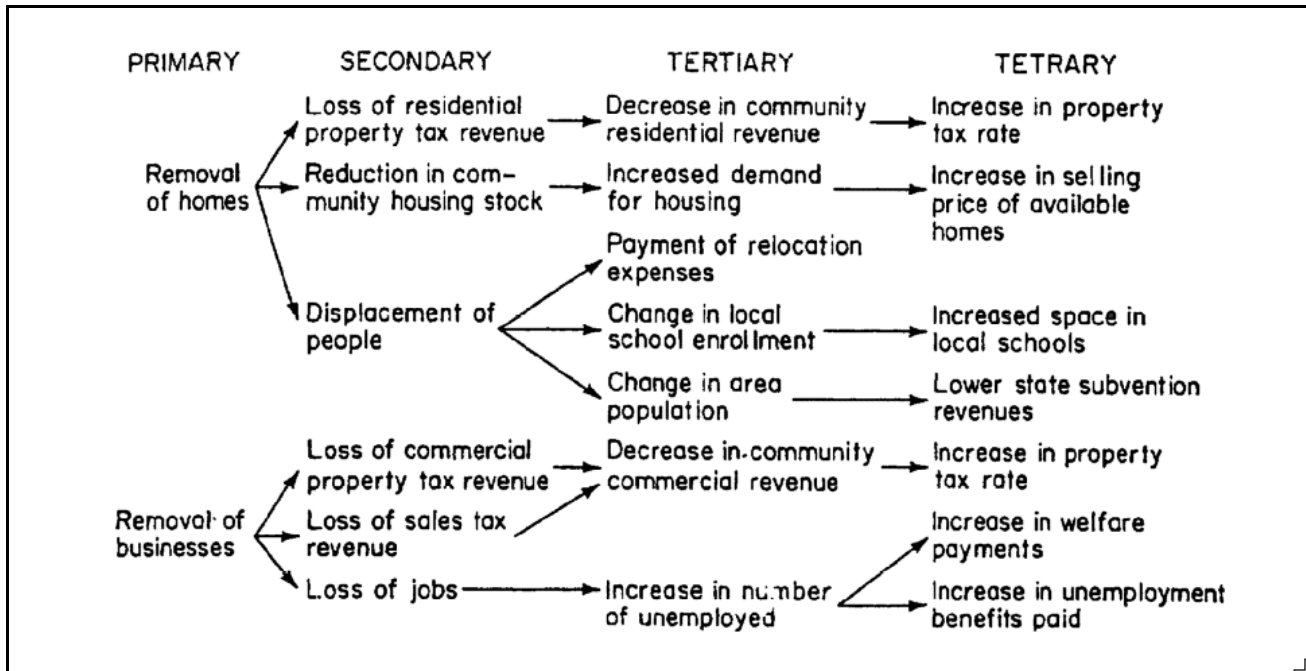

Figure A-2. Example of an "impact tree" for new freeway construction in an established downtown business district (modified from Rau and Wooten 1985)

METHODS

ALL CAUSES

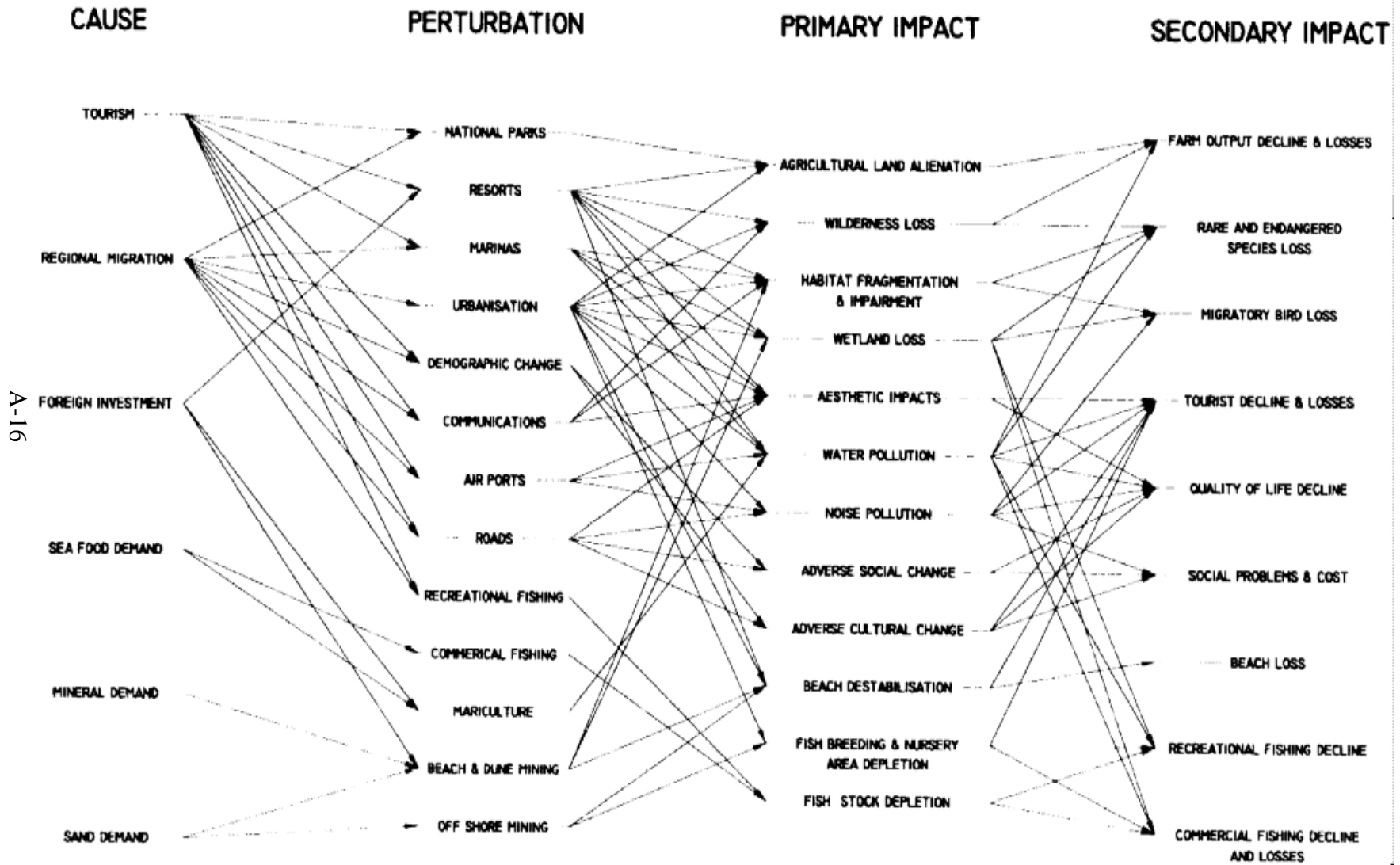

Figure A-3. A specific cause-and-effect network for coastal zone development cumulative impacts in Australia [Australian (Commonwealth) Environmental Protection Agency 1994]

A-16

METHODS

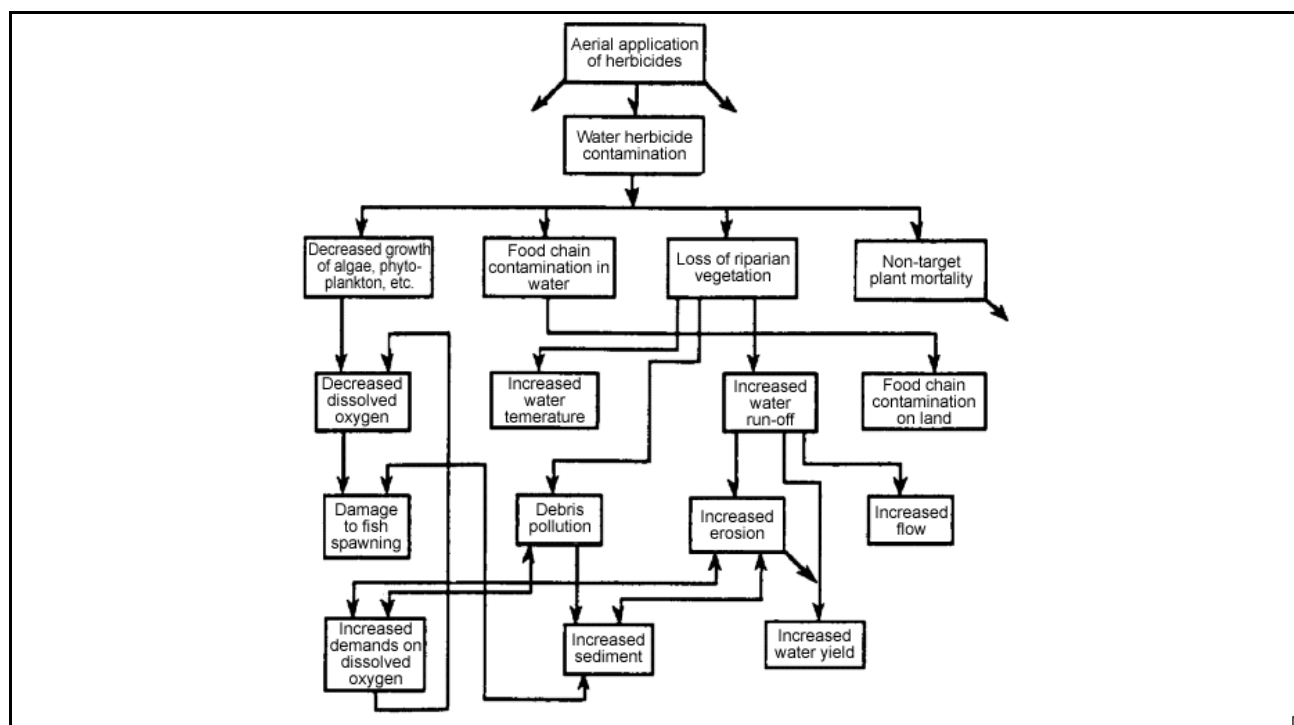

Figure A-4. System diagram showing cumulative indirect effects of aerial application of herbicide on an aquatic system (Bisset 1983).

As part of the Chesapeake Bay Restoration Plan, a cause-and-effect network analysis was conducted during a workshop charged with analyzing cumulative effects on the Bay (Williamson et al. 1987). This approach led the workshop away from focusing on development actions (near the start of the causal chains) or fish and wildlife species (near the end of the effect chains) to focusing on habitats as the hub of the cause-and-effect relationships contributing to cumulative effects on the Bay's living resources. This network analysis was instrumental in focusing the cumulative effects analysis on the appropriate ecological goals and remedial actions needed (Williamson 1993).

References

- Australian (Commonwealth) Environmental Protection Agency. 1994. Assessment of Cumulative Impacts and Strategic Assessment in Environmental Impact Assessment. Consultancy Report. May.
- Bisset, R. 1983. Methods for environmental impact analysis: recent trends and future prospects. *Journal of Environmental Management* 11:27-43.
- Gilliland, M.W. and P.G. Risser. 1977. The use of systems diagrams for environmental impact assessment. *Ecological Modelling* 3:188-209.
- Rau, J.G. and D.C. Wooten, eds. 1985. *Environmental Impact Analysis Handbook*. McGraw-Hill, New York.

METHODS

Sorensen, J.C. 1971. *A Framework of Identification and Control of Resource Degradation and Conflict in the Multiple Use of the Coastal Zone*. University of California, Berkeley, CA.

Williamson, S.C. 1993. Cumulative impacts assessment and management planning: Lessons Learned to Date. In: S.G. Hildebrand and J.B. Cannon (eds). *Environmental Analysis: the NEPA Experience*. Lewis Publishers, Boca Raton, FL. pp. 391-407.

Williamson, S.C., C.L. Armour, G.W. Kinser, S.L. Funderburk, and T.N. Hall. 1987. Cumulative impacts assessment: An application to Chesapeake Bay. *Transactions of the North American Wildlife and Natural Resources Conference* 52:377-388.

METHODS

5 MODELING

Modeling is a powerful technique for *quantifying the cause-and-effect relationships leading to cumulative effects*. Modeling can take the form of mathematical equations describing cumulative processes such as soil erosion, or it may constitute an expert system that computes the effect of various project scenarios based on a program of logical decisions. Modeling is also used in socioeconomic analyses, ranging from macroeconomic models to community-level demographics (see Methods 10 and 11).

Developing project-specific models requires substantial resources and time. For this reason, cumulative effects analysis will most often use or modify existing models. The lack of baseline data or project-specific data can also limit the use of sophisticated models. Nonetheless, modeling holds considerable promise for analyzing cumulative effects. In general, the use of models requires that an agency invest in (1) developing a given model or technique, or (2) obtaining baseline data for use in an existing model. The short-term investment usually reaps long-term benefits in analyzing cumulative effects. In some cases, the analyst may find a direct match between the model and the application to existing data. Examples where

cumulative effects are routinely modeled include the following:

- Air dispersion models
- Hydrologic regime models
- Oxygen sag models
- Soil erosion models
- Sediment transport models
- Species habitat models
- Regional economic models.

Models that are easily defended and generally recognized in the scientific community should be used. Thus, general models form the basis for most practical work under NEPA, whereas more sophisticated models are often used on a case-by-case basis. Rarely are models used to combine and evaluate cumulative effects of the proposed and other actions. Tables and matrices provide a more straightforward means of displaying alternatives and their cumulative effects on individual resources. Nonetheless, it is possible to develop an evaluative model that assigns resources to compartments and quantifies effects and relationships mathematically. Generally, the assumptions required by this approach are many, and the likelihood of public understanding and acceptance is low.

METHODS

5 EXAMPLES:

Concern for air quality has produced sophisticated air models that track local and regional emissions and estimate ambient (cumulative) pollutant concentrations. The original bubble concept in air pollution control was predicated on limiting the cumulative emissions at a site or region while allowing flexibility in the amount released by individual sources. Figure A-5 displays projected NO₂ concentration isopleths for the cumulative effects of an existing power plant and the proposed addition of a second generating unit in Healy, Alaska. This kind of model output can be combined with map overlay techniques to reveal potential adverse effects on mapped resources.

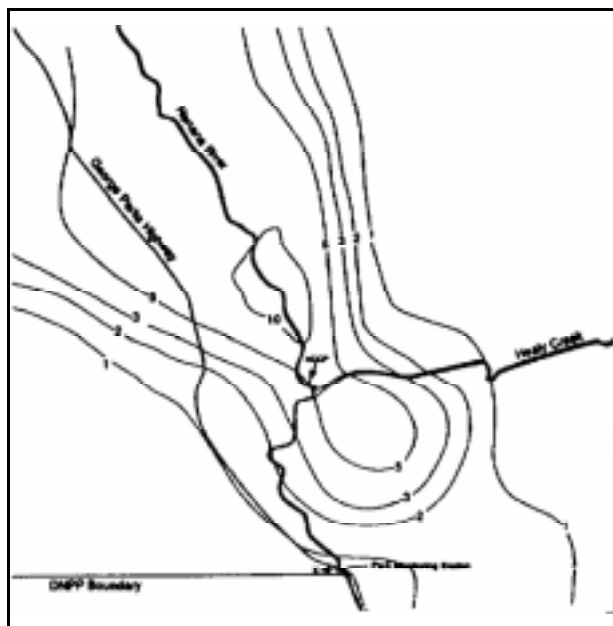

Figure A-5. Projected NO₂ concentration isopleths for combined HCCP and Unit 1 emissions, Healy, AK (Department of Energy 1993)

Water quality-based modeling is another approach to addressing cumulative effects of multiple discharges. Specifically, the cumulative effect of pollutant discharges into a waterbody can be determined through the wasteload allocation procedure under the National Pollution Discharge Elimination System (NPDES) permit process. The wasteload allocation uses a simple equation to incorporate receiving water dilution, background concentrations of pollutants, numeric water quality criteria or whole effluent toxicity information, and effluent volume for discharges into the stream of concern.

$$\text{waste load allocation} = \frac{[\text{WQC} (Q_s + Q_e) - (Q_s C_s)]}{Q_e}$$

- WQC = water quality criteria
- Q_s = upstream flow
- Q_e = effluent flow
- C_s = upstream concentration in toxic units

This wasteload allocation model sets the discharge limit so that the cumulative effect does not result in chronic toxicity to the aquatic biota of the stream. The most commonly used schemes for allocating waste loads among discharges are equal percent removal, equal effluent concentrations, and a hybrid method (where the criteria for waste reduction may not be the same for each point source).

Concerns over potential cumulative effects on aquatic resources resulting from decreases in dissolved oxygen (DO) concentrations prompted the Federal Energy Regulatory Commission (FERC) to model the DO in river reaches encompassing 19 potential hydroelectric generation sites in the Upper Ohio River Basin (FERC 1988). Although it is well known that introducing hydropower projects will affect DO

METHODS

concentrations by changing the amount of aeration that takes place at existing dams (from spillage over the dam), the cumulative effect on individual river reaches could only be determined by developing a simulation model (Figure A-6). This model first determined the amount of aeration provided by the dams, and then determined the change in DO caused by installing hydropower facilities. The amount of DO provided by dams was quantified by fitting field data to a statistical model. Then a mathematical model based on known biochemical oxygen demand (BOD) and hydraulic characteristics was developed to determine how changes in aeration at each dam where hydropower was proposed would affect DO concentrations over the entire study area. Ultimately, the effects of proposed hydropower projects on DO concentrations were analyzed under appropriate flow conditions, and the cumulative effects of different alternatives (combinations of projects) on target resources were defined.

The cumulative effects on species of concern can be modeled by quantifying specific mortality factors (e.g., entrainment of migrating species in the turbines of multiple hydropower facilities) or loss of suitable habitat. The cumulative effects of micro-hydro development on the fisheries of the Swan River drainage in Montana was modeled using the bull trout as the primary species of concern (Leathe and Enk 1985). A land-type-based watershed model was used to estimate future cumulative sediment loads resulting from a combination of forest management and micro-hydro development scenarios. The relationship of sediment load to substrate quality was determined and the substrate quality score was correlated with the number of bull trout. Based on these models, the cumulative effect on fisheries from scenarios containing 4 to 20 micro-hydro projects was estimated. Within the drainage, a 7% reduction in juvenile bull trout abundance was attributed to forest road construction; 13% to 24% losses were predicted for micro-hydro project development.

Truett et al. (1994) concluded that the best approach for assessing the cumulative effects on

wildlife is to focus on the habitat factors that control the distributions and abundances of

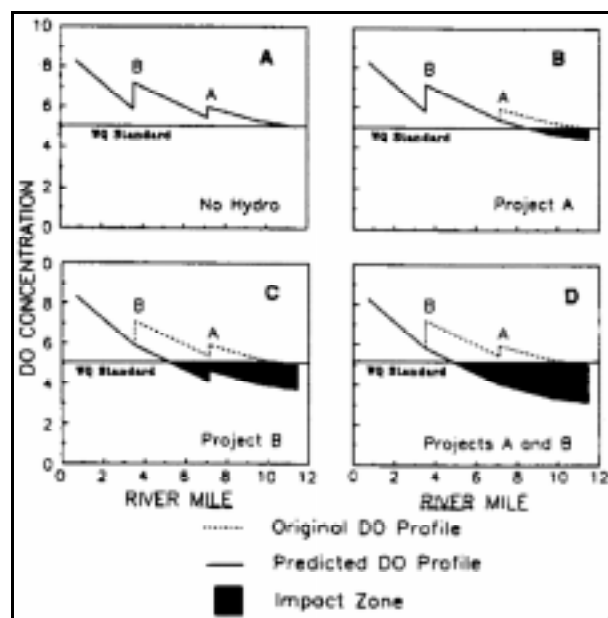

Figure A-6. Cumulative effects on dissolved oxygen caused by hydroelectric development, reduced spillages, and reduced aeration at dams (FERC 1988)

wildlife populations. The most commonly used models of resource-habitat relationships are the Habitat Evaluation Procedures (HEP; U.S. Fish and Wildlife Service 1980) and Instream Flow Incremental Methodology (IFIM; Armour et al. 1984) developed by the U.S. Fish and Wildlife Service. HEP uses Habitat Suitability Index (HSI) models to provide estimates of habitat quality (Schamberger et al. 1982; Hayes 1989). An HSI is developed for each species by aggregating functional values for specific habitat parameters known to support the species of interest. HSI models have also been developed for a few animal communities such as those found in shelterbelts (Schroeder 1986). The cumulative effect of multiple activities on a species can be determined by estimating the number of habitat units (combined HSIs for each habitat available to the species) affected in the area. HEP and IFIM models provide a common currency (habitat suitability) that can be debited by a wide variety of cumulative effects.

METHODS

Models are routinely used to assess regional economic effects. When the need to include socioeconomic considerations in NEPA analyses arose, the U.S. Army developed the Economic Impact Forecast System (EIFS) as a model that (1) was based in sound theory, (2) was accepted by the scientific community, and (3) could use readily available data. EIFS is discussed in more detail in the section on Economic Impact Analysis (Method 10).

Although the primary use of models in cumulative effects analysis is to quantify cause-and-effect relationships, optimization and simulation modeling can be used to evaluate among alternatives or against a predefined set of goals. Optimization methods (such as linear programming) address cumulative effects by explicitly incorporating multiple resources and seeking an optimum level for each resource relative to project objectives. Methods range from simple algebraic equations that are solved for variables of set ranges to complex versions including nonlinear functions, layers of optimizations, probabilities, and stochastic variables (Stull et al. 1987). Grygier and Stedinger (1985) used this technique to optimize energy production under the constraints of other goals including water supply, minimum flows, and reservoir levels. Simulation enables the practitioner to model an environmental or socioeconomic system, and simulate the effects of various actions on the system (as described by functional interactions among system components) over time and space. This is the most difficult of cumulative effects analysis methods, yet potentially most rewarding because it is capable of producing most nearly what a practitioner would want—a decisionmaking tool.

References

Armour, C.L., R.J. Fisher, and J.W. Terrell. 1984. Comparison of the Use of the Habitat Evaluation Procedures (HEP) and the Instream Flow Incremental Methodology (IFIM) in Aquatic Analyses. U.S. Fish and Wildlife Service, Western Energy and Land Use Team, Fort Collins, CO. FWS/OBS-84/11.

Federal Energy Regulatory Commission (FERC). 1988. Final Environmental Impact Statement. Hydroelectric Development in the Upper Ohio River Basin. Ohio, Pennsylvania, West Virginia. FERC Docket No. EL85-19-114. Federal Energy Regulatory Commission, Office of Hydropower Licensing. Washington, DC. September. FERC/FEIS-0051.

Grygier, J.C. and J.R. Stedinger. 1985. Algorithms for optimizing hydropower development. *Water Resources Research* 16:14-20.

Hayes, R.L. 1989. Micro-HSI master model library., cover type list and variable lexicon. Reference Manual v 2.1. U.S. Fish and Wildlife Service, Fort Collins, CO.

Leathe, S.A. and M.D. Enk. 1985. Cumulative Effects of Micro-Hydro Development on the Fisheries of the Swan River Drainage, Montana. I: Summary Report. Prepared for the Bonneville Power Administration., Portland, OR. 114 pp. + appendices.

Schamberger, M., A.H. Farmer, and J.W. Terrell. 1982. Habitat Suitability Index Models: Introduction. U.S. Fish and Wildlife Service, Washington, DC.

Schroeder, R.L. 1986. Habitat Suitability Index Models: Wildlife Species Richness in Shelterbelts. Biological Report 82(10.128). U.S. Fish and Wildlife Service, Washington, DC. 17 pp.

METHODS

Stull, E.A., K.E. LaGory, and W.S. Vinikour. 1987. Methodologies for assessing the cumulative environmental effects of hydroelectric development on fish and wildlife in the Columbia River Basin – Volume 2: Example and procedural guidelines. Final report to Bonneville Power Administration, Portland, OR. DOE/BP-19461-4.

Truett, J.C., H.L. Short, and S.C. Williamson. 1994. Ecological impact assessment. In: T.A. Bookhout, ed. *Research and Management Techniques For Wildlife and Habitats*. The Wildlife Society, Bethesda, MD pp. 607-622.

U.S. Department of Energy. 1993. Final Environmental Impact Statement for the Proposed Healy Clean Coal Project. DOE/EIS-0186.

U.S. Fish and Wildlife Service. 1980. Habitat Evaluation Procedures. ESM 102. U.S. Fish and Wildlife Service, Division of Ecological Services, Washington, DC.

METHODS

6

TRENDS ANALYSIS

Trends analysis assesses the status of resources, ecosystems, and human communities over time and usually results in the graphical projection of past or future conditions. Changes in the occurrence or intensity of stress over time can also be determined. Trends analysis *provides the historical context that is critical to assessing the cumulative effects of proposed actions*. Specifically, trends analysis can assist the cumulative effects analyst by

- **Identifying cumulative effects problems.** When trends analysis demonstrates that a substantial amount of a resource has been lost, it usually reveals a cumulative effects problem that may be exacerbated by additional actions. For example, historical declines in a fishery resource may indicate that the fishery is near the threshold of population collapse.
- **Establishing appropriate environmental baselines.** When data on the current state of a resource are lacking (or too variable), trends data can be used to describe the existing condition. Trends information can also be used to develop historical baselines or regional goals against which to evaluate restoration efforts.
- **Projecting future cumulative effects.** Trends analysis can identify historical cause-and-effect relationships

between stresses and resources or ecosystems. Common cumulative effects relationships can be used to predict future effects whenever the environmental conditions are similar. Historical trends may also reveal threshold points where cumulative effects become significant or qualitatively different.

By documenting the cumulative effects on the condition of resources over time, trends analyses have been used as planners to assist with the orderly development of communities (by charting the course of economic development), and by wildlife managers to develop appropriate harvest guidelines (by recording populations trends in species). Changes in the condition of resources or ecosystems can be illustrated in both simple and complex forms. A simple trends analysis might produce a line graph showing decreasing numbers of animals from annual surveys. Changes in habitat pattern might be illustrated with a series of figures, or in a 3-dimensional graphic where the amount of change is portrayed on the vertical axis. Video simulations can be used to show complex changes in geographic or aesthetic resources. Time-series information from aerial photographs or satellite imagery are increasingly available for trends analysis across the United States.

METHODS

6 EXAMPLES:

Trends identified from long-term data sets greatly enhance the evaluation of cumulative effects analyses on individual species. For example, the U.S. Fish and Wildlife Service's Breeding Bird Survey (BBS) has identified declining bird populations that may be at greater risk from future cumulative effects (Robbins et al. 1986). As is the case with most long-term records, data gaps in the BBS require

using advanced statistical methods to ensure accurate interpretation of trends. In this case, proportional trends for each survey route were estimated and then weighted to account for areal and data influences (Figure A-7). Trends analyses of bird surveys have identified a number of species with substantial declines in numbers, including many migratory songbirds (Atkins et al. 1990; Terborgh 1992).

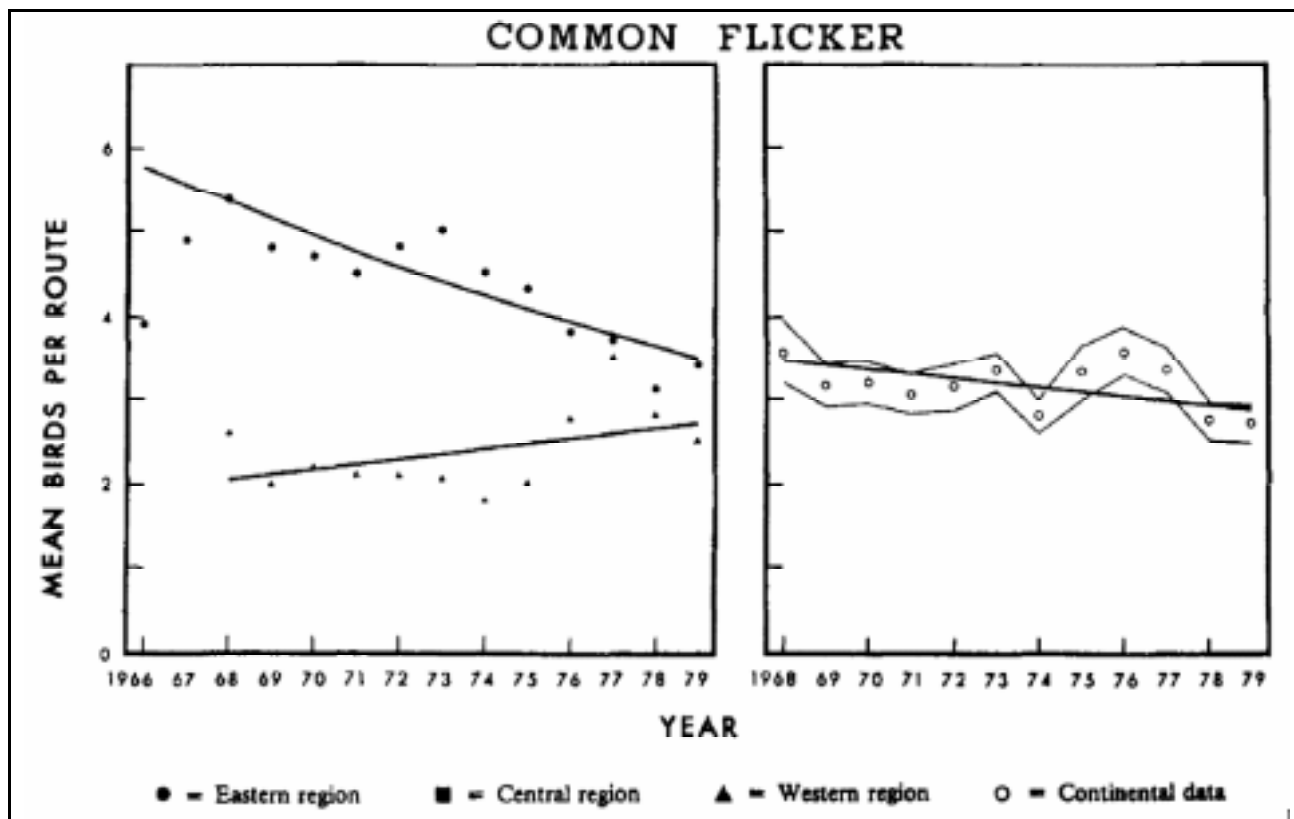

Figure A-7. Common flicker population trends (Robbins et al. 1986)

METHODS

Trends in the abundance and distribution of habitats are one of the most important indicators of cumulative effects problems. Figure A-8 dramatically illustrates the trend toward fragmentation of forested areas in Wisconsin (Curtis 1956 cited in Terborgh 1989). A recent study by the U.S. Army Corps of Engineers, in cooperation with U.S. EPA, Fish and Wildlife Service, and NOAA (1993), addressed historical trends in special aquatic habitats of Commencement Bay, WA, resulting from numerous dredge and fill activities since 1877. To address changes over 140 years, the trends analysis study combined historical literature with the photographic record. The use of remotely sensed photographic imagery allowed analysts to combine measures of the areal extent of spoil disposal with written information on the volume of material dredged, and produced a dramatic illustration of downward trends in the area of both intertidal mudflats and marshes (Table A-2).

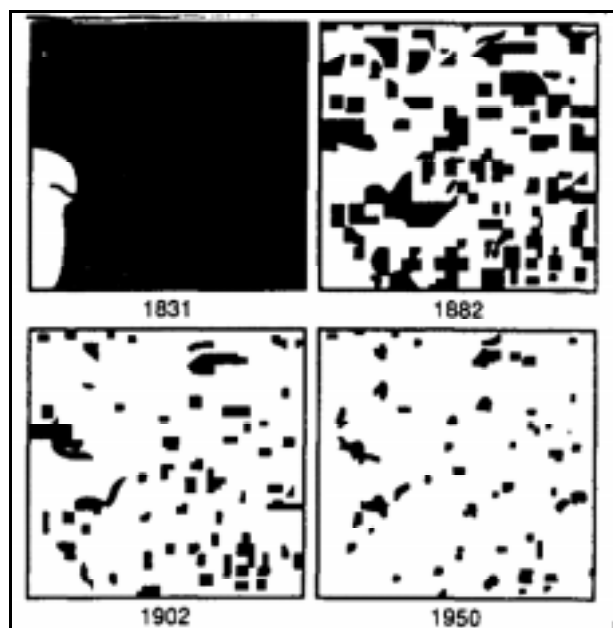

Figure A-8. Cadiz township forest fragmentation (Curtis 1956 cited in Terborgh 1989)

Many other examples of historical losses of wetlands have been reported by the U.S. Fish and Wildlife Service's National Wetlands Inventory (NWI; Dahl et al. 1991). In addition to identifying (and quantifying) this cumulative effects problem, the NWI trends analysis has produced statistics (such as the remaining acreage of different wetlands types) that can be used to predict thresholds where future wetlands losses will likely affect watershed functioning. The "synoptic approach" to cumulative effects analysis developed by the U.S. EPA Environmental Research Laboratory in Corvallis (Leibowitz et al. 1992) proposes to use this information as a quantitative means of comparing wetlands losses among watersheds and determining where future wetland losses will have the greatest effect.

Trends analysis can also be used to construct the environmental baseline for cumulative effects analysis when adequate data on the state of a resource are lacking or are too variable. For example, sediment cores drawn from lakes or estuaries can often be used to obtain a more accurate picture of the state of contamination than can standard sediment samples. Landings of commercial fish species are notoriously variable, but historical trends can identify appropriate baseline population levels as targets for restoration efforts.

Trends analysis in land disturbance have also been used to estimate future cumulative effects based on the causal relationship between land use and resource degradation. Time-series data and aerial photos illustrating trends in land disturbance in Elkhorn Slough, CA, over a 50-year period were used to predict the effect of future residential development (Dickert and Tuttle 1985). In addition, the trends analysis produced a historical trends target that was deemed acceptable for final buildout of the area.

METHODS

Historic Period	Habitat Type	Historical Records of Lost Habitat	Total Lost Habitat (includes historical records and photographic evidence)	Acres Remaining
1877 - 1894	mudflat	11	0	2,074
	marsh	20	0	3,874
1894 - 1907	mudflat	208	605	1,469
	marsh	41	415	3,459
1907 - 1917	mudflat	51	542	927
	marsh	35	64	3,395
1917 - 1927	mudflat	48	162	765
	marsh	0	72	3,320
1927 - 1941	mudflat	143	133	632
	marsh	399	1,676	1,44
1941 - Present	mudflat	105	412	187
	marsh	1,557	1,587	57
TOTALS	mudflat	566	1,54	
	marsh	1,052	3,814	

References

- Askins, R.A., J.F. Lynch, and R. Greenberg. 1990. Population declines in migratory birds in eastern North America. *Current Ornithology* 7:1-57.
- Curtis, J.T. 1956. The modification of mid-latitude grasslands and forests by man. In *Man's Role in Changing the Face of the Earth*, edited by W.L. Thomas, 721-736. University of Chicago Press, IL.
- Dahl, T.E., C.E. Johnson, and W.E. Frayer. 1991. Wetlands: Status and Trends in the Conterminous United States Mid-1970's to Mid-1980's. U.S. Department of the Interior, Fish and Wildlife Service, Washington, DC. 28 pp.
- Dickert, T.G. and A.E. Tuttle. 1985. Cumulative impact assessment in environmental planning: A coastal wetland watershed example. *Environmental Impact Assessment Review* 5:37-64.
- Leibowitz, S.G., B. Abbruzzese, P. Adamus, L. Hughes, and J. Irish. 1992. A Synoptic Approach to Cumulative Impact Assessment—A Proposed Methodology. U.S. Environmental Protection Agency, Environmental Research Laboratory, Corvallis, OR. EPA/600/R-92/167.
- Robbins, C.S., D. Bystrak, P.H. Geissler. 1986. The Breeding Bird Survey: Its First Fifteen Years, 1965-1979. USDOJ, Fish and Wildlife Service, Resource Publication 157. Washington, DC.
- Terborgh, J. 1989. *Where Have All the Birds Gone?* Princeton University Press, NJ. 207 pp.
- Terborgh, J. 1992. Why American Songbirds are Vanishing. *Scientific American* 266(5):98-104.
- U.S. Army Corps of Engineers (USACE)A, U.S. Fish and Wildlife Service, and NOAA. 1993. Commencement Bay Cumulative Impact Study. Vol. I Assessment of Impacts. U.S. Army Corps of Engineers, Seattle, WA. May/June.

METHODS

7

OVERLAY MAPPING AND GIS

Overlay mapping and geographic information systems (GIS) incorporate locational information into cumulative effects analysis. Simple mapping characterizes the spatial aspects of resources, ecosystems, and human communities and helps set the boundaries of the analysis. Overlay mapping can directly evaluate cumulative effects by identifying areas where effects will be the greatest. Mapping and GIS can also address concerns, such as landscape connectivity, that are difficult, if not impossible, to address with other methods. Map overlays *are extremely useful for any form of visual representation.*

The most direct use of overlay mapping for analyzing cumulative effects is "impact-oriented," wherein a composite cumulative effects map is produced by overlaying individual effects from different actions. Examples include the combined effects of both air deposition and water discharge of contaminants to a river, as well as the cumulative effects of multiple land uses in a forested watershed. The more common map overlay approach, however, combines thematic maps of different landscape features to rate areas or resources as to their suitability for development or risk from degradation. In this "resource-oriented" approach, cumulative effects in specific areas can be compared to land suitability determinations (resource or ecosystem thresholds) for those areas. The result is a suitability map that combines development opportunities and environmental and socioeconomic constraints (e.g., both endangered species habitats and public transportation routes) to

disturbance or the areas where disturbance will have the greatest consequences (e.g., those that

identify parcels suited to each activity type (McHarg 1969).

Resource-oriented overlay mapping supports the planning approach to cumulative effects analysis and is often called resource capability analysis. Resource capability analysis can be used to optimize the integration of a site's natural and cultural features with various site design elements (Rubenstein 1987), or to minimize wastefulness in resource utilization (McKenzie 1975). Resource capability analysis uses opportunity, constraint, and suitability maps (Rubenstein 1987). Opportunity maps generally depict conditions related to factors such as soil types or topographic slopes that are suitable for development; constraint maps depict areas that for various reasons, such as the presence of wetlands, floodplains, or cultural resources, are not conducive to development. The land suitability map combines the information in the opportunity and constraints maps to identify those areas best suited for the activities planned.

Suitability ratings can be used to express the responses of resources, ecosystems, and human communities in the absence of more sophisticated quantitative cause-and-effect models (Contant and Wiggins 1993). Where these suitability ratings are based on thresholds above which effects exceed the capacity of the affected resources to sustain themselves, the evaluation is equivalent to carrying capacity analysis. Resource-oriented overlay mapping usually identifies the areas most sensitive to

are most valued or have endured the greatest past losses).

METHODS

Overlay maps and land suitability maps have rapidly evolved from handmade transparencies to GIS-based computer overlays (for potential problems see Bailey 1988). In the simplest case, map layers are hand drawn on transparent sheets and then overlain. Each sheet represents a single map layer containing a certain type of information. Within each sheet (or overlay), the importance (or weight) assigned to different data categories is represented by the degree of shading used. The shading seen when all map overlays are stacked atop each other reveals graphically the overall suitability of different areas within the mapped region for the

user-defined purpose. In the effect-oriented approach, darker shading may be used to identify areas subject to the greatest cumulative effects (from multiple actions).

Using a GIS to implement overlay mapping allows the analyst to electronically overlay natural and cultural features and produce composite maps quickly (Johnson et al. 1988). In some cases, GIS maps are derived directly from satellite images using land cover interpretation algorithms. Like the user of the manual transparent map overlay technique, the GIS user can develop weighted functions to assign numeric weights to each map area (or groupings of grid cells) within a map layer. Such weights might be determined by an expert in the field, or based on a statistical classification drawn from field measurements.

METHODS

7 EXAMPLES:

Examples of the use of overlay mapping and GIS to analyze cumulative effects include both the effect-oriented approach (e.g., where two or more contaminant sources are mapped over a single resource) and the resource-oriented approach (e.g., where the map overlays are used to characterize land areas in terms of their suitability for development). The former approach is typified by GIS-based groundwater analyses where multiple plumes of contaminated water are overlain on the aquifer of interest to determine the cumulative effects. Many other resources and ecosystems have important geographical characteristics that must be considered in analyzing cumulative effects. For example, overlay mapping can reveal the cumulative fragmentation of a spatially contiguous forest (critical to many migratory songbirds) from activities such as road and building construction. In the Corridor Selection Supplemental Draft EIS for the construction of the Appalachian Corridor H highway near Elkins, West Virginia (West Virginia DOT 1992), GIS map overlays produced estimates of the amount of forest fragmentation, reduction in core forest area, and spatial contact of construction with remote habitat areas.

The resource-oriented overlay mapping approach is commonly used to select the preferred development option (e.g., the right-of-way route that minimizes cumulative effects on resources, ecosystems, and human communities). In his classic *Design With Nature*, Ian McHarg (1969) described the use of map overlays for planning coastal island development, highways, open space in Philadelphia, suburban growth near Baltimore, land use on Staten Island, and regional development around metropolitan Washington, D.C. In the highway development example, he used overlay mapping to determine

a "minimum-social-cost alignment" to replace the originally proposed highway corridor.

Master plans often use resource capability analysis to address the cumulative effects of multiple actions. The resources to be included in the capability analysis depend on the activities being undertaken, and analyses range from comprehensive assessments of all physical, biological, and socioeconomic factors in a regional planning area to limited analyses of the potential for sediment runoff related to the slope, soil, and permeability of a given plot of land. For example, overlays of a site's topographic features (e.g., geology, soils, slope, and vegetation) can be used to designate areas where construction will not contribute to cumulative runoff problems (i.e., soils with low erosion potential). Overlay mapping is also critical to planning conflicting land uses, such as combat training activities and natural resource conservation on military installations. The intersection of impact areas (e.g., aircraft flight corridors, tank maneuvers, large weapon firing areas, ordinance impact areas) and sensitive environments (e.g., wildlife refuges and endangered species habitats) can be determined through overlay mapping as illustrated in Figure A-9 (produced from map archives, Department of the Navy, Naval Air Station Patuxent River, MD, 1996).

Overlay mapping and GIS can also be used to document past cumulative effects and help predict future effects. Walker et al. (1987) used remote sensing data and GIS to evaluate the indirect effects of oil field development in the Prudhoe Bay Oil Field, Alaska. Aerial photographs revealed surface disturbance (flooding

METHODS

and thermokarst) extending beyond the areas directly affected by construction. These unanticipated effects on frozen arctic soils and thaw-lake wetlands constitute an important cumulative effects problem for oil field activities. Overlay mapping of the spatial properties of areas (e.g., vegetation, amount of open water, land and surface form types, and soil type) where these indirect effects were more pronounced can be used to predict future cumulative effects and better plan resource extraction in this fragile ecosystem.

The promise of GIS as a tool for solving cumulative effects problems is evidenced by the rapidly increasing applications of GIS to land management of forests (Sample 1994) and wetlands (Lyon and McCarthy 1995). Jerry Franklin (1994) states that GIS may be the most important technology resource managers have acquired in recent memory. He predicts that GIS will be invaluable in (1) inventory and monitoring, (2) management planning, (3) policy setting, (4) research, and (5) consensual decisionmaking. In a much publicized example, the

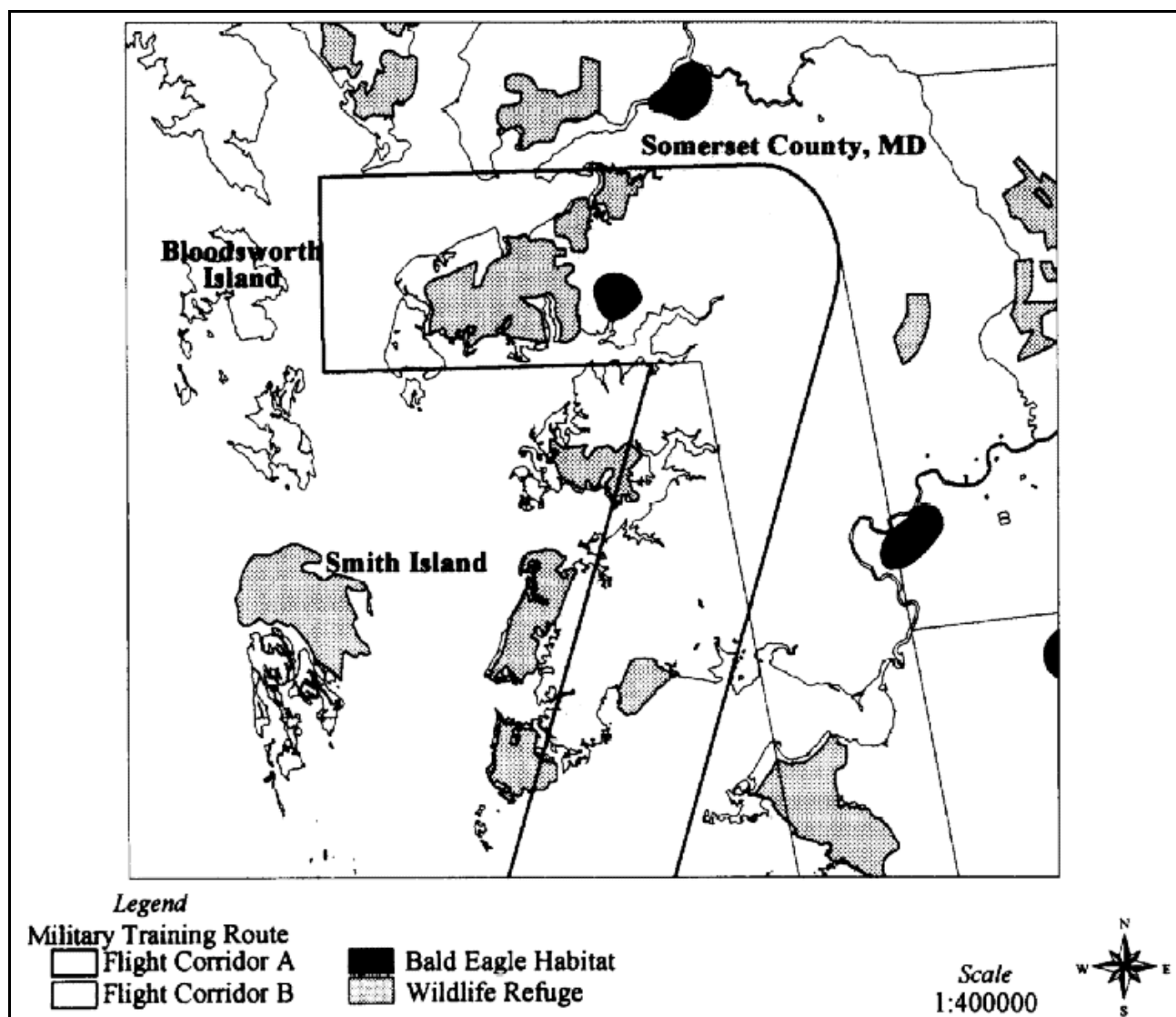

Figure A-9. Hypothetical intersection between aviation flight corridors and environmental resources near a typical U.S. military installation (Department of the Navy 1996)

METHODS

resolution of the Pacific Northwest forest controversy would have been impossible without GIS. Only when GIS was combined with remote sensing information was the actual extent (or lack) of old growth forest determined. Perhaps more importantly, various scientific panels were charged with developing and evaluating alternatives for protecting late-successional forest ecosystems and associated species (e.g., northern spotted owl). Only when an effective GIS capability was developed, was it possible to display and modify the alternatives before decision-makers (including Congressional delegations) so that reasonable consensus could be achieved.

References

- Bailey, R.G. 1988. Problems with overlay mapping for planning and their implications for geographic information systems. *Environmental Management* 12:11-17.
- Contant, C.K. and L.L. Wiggins. 1993. Toward Defining and Assessing Cumulative Impacts: Practical and Theoretical Considerations. In: S.G. Hildebrand and J.B. Cannon. eds. *Environmental Analysis: The NEPA Experience*. Lewis Publishers, Boca Raton, FL. pp. 336-356.
- Department of the Navy. 1996. Hypothetical intersection between aviation flight corridors and environmental resources near a typical U.S. military installation. Map created by the Joint Innovative Interdisciplinary Solutions Team (JIIST) Program Office, Naval Air Station Patuxent River, MD.
- Franklin, J.F. 1994. Developing information essential to policy, planning, and management decision-making: The promise of GIS. In: V.A. Sample, ed. *Remote Sensing and GIS in Ecosystem Management*. Island Press, Washington, DC. pp. 18-24.
- Johnson, C.A., N.E. Detenbeck, J.P. Bonde and G.J. Niemi. 1988. Geographic Information Systems for Cumulative Impact Assessment. *American Society of Photogrammetry and Remote Sensing*. 54(11):1609-1615.
- Lyon, J.G. and J. McCarthy. 1995. *Wetland and Environmental Applications of GIS*. Lewis Publishers, Boca Raton, FL. 368 pp.
- McHarg, I. 1969. *Design with Nature*. Natural History Press, New York, NY. 197 pp.
- McKenzie, G.D. 1975. Physical Environment in Regional Planning. In *Regional Environmental Management*, L.E. Coate and P.A. Bonner eds. John Wiley & Sons, New York, New York, pp 235-244.
- Rubenstein, H.M. 1987. *A Guide to Site and Environmental Planning*. John Wiley & Sons, New York, New York, pp. 7-53.
- Sample, V.A., ed. 1994. *Remote Sensing and GIS in Ecosystem Management*. Island Press, Washington, DC. 369 pp.
- Walker, D.A., P.J. Webber, E.F. Binnian, K.R. Everett, N.D. Lederer, E.A. Nordstrand, and M.D. Walker. 1987. Cumulative impacts of oil fields on northern Alaskan landscapes. *Science* 238:757-761.
- West Virginia Department of Transportation (DOT). 1992. Corridor Selection Supplemental Draft Environmental Impact Statement (SDEIS): Appalachian Corridor H Elkins to Interstate 81. West Virginia DOT, Division of Highways, Charleston, WV.

METHODS

8

CARRYING CAPACITY ANALYSIS

Carrying capacity analysis derives from the fact that inherent limits, or thresholds, exist for many environmental and socioeconomic systems. Carrying capacity in the ecological context *is defined as the threshold of stress below which populations and ecosystem functions can be sustained*. In the social context, the carrying capacity of a region is the sum of human activities that can be maintained while providing the level of services (including ecological services) desired by the populace. When cumulative effects exceed the carrying capacity of a resource, ecosystem, and human community, the consequences are significant.

As a method for evaluating cumulative effects, carrying capacity analysis serves to identify thresholds for the resources and systems of concern (as constraints on development) and provide mechanisms to monitor the incremental use of unused capacity. Carrying capacity analysis begins with the identification of potentially limiting factors (e.g., the supply of water in a desert riparian ecosystem). Mathematical equations are then developed to describe the capacity of the resource or system in terms of numerical limits (thresholds) imposed by each limiting factor. In this way, projects can be systematically evaluated in terms of their effect on the remaining capacity of limiting factors (Contant and Wiggins 1993).

Carrying capacity analysis can be especially useful for assessing cumulative effects in the following situations:

- Infrastructure and public facilities
- Air and water quality
- Wildlife populations
- Recreational use of natural areas
- Land use planning

The determination of carrying capacity is straightforward for public facilities such as water supply systems, sewage treatment systems, and traffic systems. A reservoir can only supply water to a finite number of consumptive users. In the case of air and water quality control programs, statutory limits (or standards) are regulatory thresholds of the carrying capacity of air or water in the region of interest. Cumulative effects can be estimated through physical and mathematical models and then compared with these standards. Unlike engineered systems, thresholds involving subjective human uses must be based on goal-oriented statements of public opinion and can only be obtained through opinion survey information or the scoping process. Such thresholds include the degree of enjoyment obtained from a recreational experience. In natural systems, the carrying capacity of well-studied populations (usually game species) can be adequately modeled, but the capacity of whole ecosystems to withstand and recover from stress (i.e., their resilience) has yet to be modeled precisely and at best is expressed in gross probabilistic terms (i.e., the likelihood of a set of events occurring).

METHODS

8 EXAMPLES:

The air and water quality criteria provisions of the Clean Air Act and Clean Water Act, respectively, represent carrying capacity approaches to dealing with cumulative effects (as opposed to best available technology approaches). Under the Clean Air Act Amendments of 1990, states measure the cumulative effect of all sources on the concentration of air pollutants in specified attainment areas using regional models. New stationary sources are not permitted if they are determined to cause, in the aggregate, the concentration of a pollutant of concern to exceed its standard (the presumed carrying capacity of the area). Similarly, total maximum daily loads (TMDLs) are calculated for water bodies receiving point and nonpoint discharges as part of the NPDES permit process to ensure that the cumulative effects on water quality do not exceed the assimilation capacity of the receiving waters. If the cumulative effect remains below standards, capacities are not exceeded, and new proposals can be authorized (Contant and Wiggins 1993).

Wildlife and fisheries managers have been conducting carrying capacity analyses for many years (Smith 1974). Specifically, managers have used the maximum-sustained-yield concept to determine the amount of harvest of fish or game populations that will not result in deterioration of the population (i.e., not exceed the capacity of the population to renew itself). The U.S. Forest Service developed *Management Recommendations for the Northern Goshawk in the Southwestern United States* based on the concern that the goshawk, a forest habitat generalist, may be experiencing declining populations and reproduction associated with tree harvests and other factors affecting the carrying capacity of western forests (Reynolds et al. 1992). These guidelines will be used to develop national forest plans in the Southwestern Region that will

maintain the forest carrying capacity (i.e., specific habitat attributes and important prey species) needed to sustain goshawk populations despite the cumulative effects of human influences and natural perturbations, including loss of an herbaceous and shrubby understory, reduction in the amount of older forests, and increased areas of dense tree regeneration.

Managers of natural areas also employ the carrying capacity concept to prevent parks and other recreation areas from becoming overused.

Techniques used to evaluate the cumulative effects of recreation applications involve use thresholds (i.e., standards) based on social values (e.g., opportunities for solitude) and ecological factors (e.g., presence of rare and endangered species). The recreational carrying capacity concept is explicitly linked to the notion of nondegradation, where current conditions set a baseline or standard for environmental quality. For example, Forest Service researchers have devised the Limits of Acceptable Change process for setting and monitoring recreational carrying capacity in a wilderness area (Stankey et al. 1985). The U.S. Army Corps of Engineers (1993) addressed both the social carrying capacity and the resource carrying capacity of the Fox waterway in Illinois as it developed permitting policy guidelines for the area. Based on a definition of when people feel crowded, the social carrying capacity was determined to be approximately 854 boats and 236 jet skis on the open areas of the waterway. Based on a water quality definition that used a threshold of water clarity needed for vegetation growth, the resource carrying capacity was determined to be 350 cruising boats (i.e., the number that could use the deeper water areas that did not support sensitive vegetation).

METHODS

Carrying capacity analysis is a critical part of land use planning for sustainable development. Ideally, knowledge of the carrying capacity of an area provides the basis for developing suitability maps to guide future growth (including proposed federal projects). When applied to human communities, carrying capacity can be defined as "the ability of a natural or man-made system to absorb population growth or physical development without significant degradation

or breakdown" (Schneider et al. 1978). As part of comprehensive planning for Sanibel Island, Florida, land capability analysis was conducted to determine the cumulative effects of development actions on the structure and functions of the ecological zones of the island (Clark 1976). This analysis led to a comprehensive set of management guidelines based on the carrying capacity of these natural systems for sustaining human development. Figure A-10 illustrates the combinations of population numbers and population density that are possible without exceeding the carrying capacity of interior wetlands to assimilate runoff from developed areas.

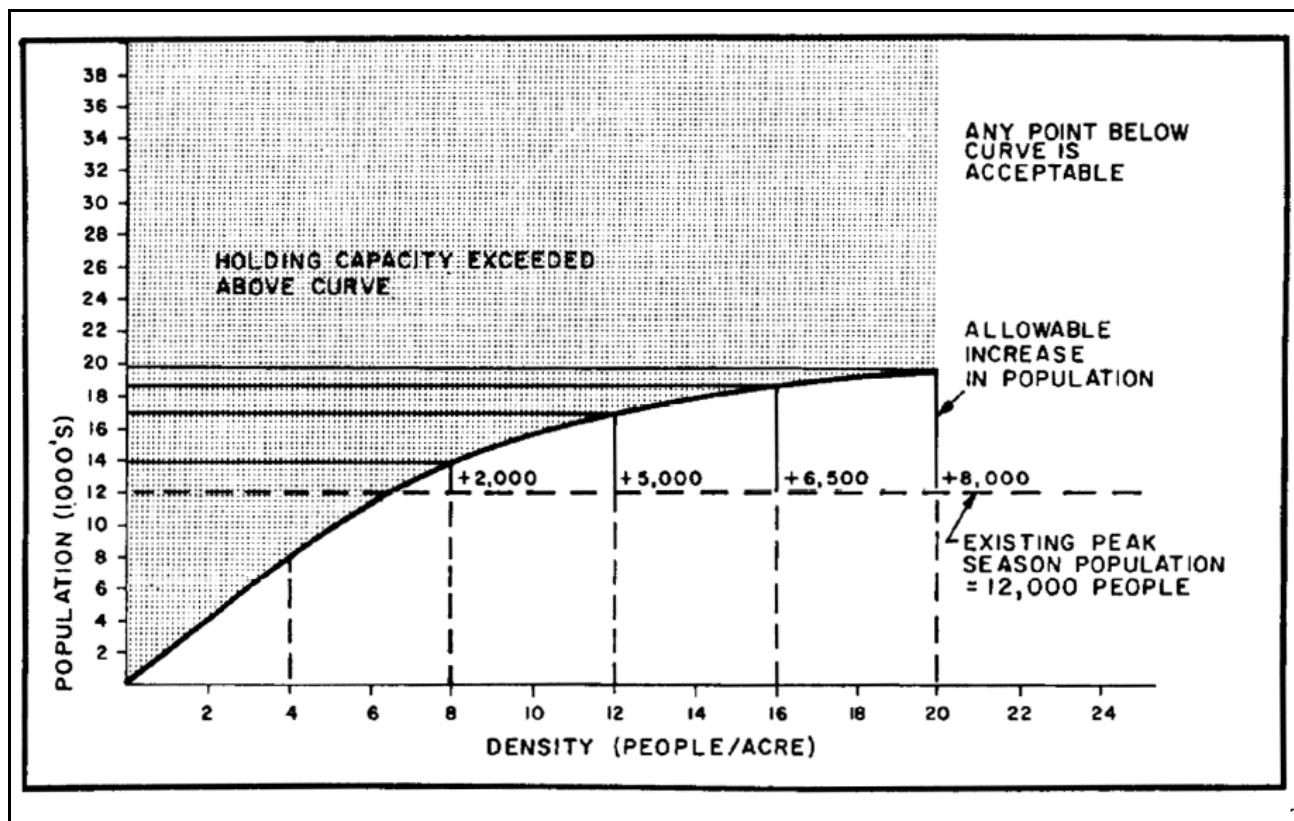

Figure A-10. Sanibel Island, Florida population versus runoff assimilation capacity (Clark 1976)

METHODS

References

Clark, J. 1976. The Sanibel Island Report: Formulation of a Comprehensive Plan Based on Natural Systems. Conservation Foundation, Washington, DC.

Contant, C.K. and Wiggins, L.L. 1993. Toward defining and assessing cumulative impacts: Practical and theoretical considerations. in Hildebrand, S.G. and Cannon, J.B., eds. *Environmental Analysis: the NEPA Experience*. Lewis Publishers, Boca Raton, Florida.

Reynolds, R.T., R.T. Graham, M.H. Reiser, R.L. Bassett, P.L. Kennedy, D.A. Boyce, Jr., G. Goodwin, R. Smith, and E.L. Fisher. 1992. Management Recommendations for the Northern Goshawk in the Southwestern United States. USDA Forest Service, General Technical Report RM-217, Fort Collins, CO.

Schneider, D.M., Godschalk, D.B., and Axler, N. 1978. The Carrying Capacity Concept As a Planning Tool. Planning Advisory Service Report Number 338. The American Planning Association, Chicago, Illinois.

Smith, R.L. 1974. *Ecology and Field Biology*, Second Edition. Harper and Row, Publishers. New York, NY.

Stankey, G.H., Cole, D.N., Lucas, R.C., Petersen, M.E. and Frissell, Sidney S. 1985. The Limits of Acceptable Change (LAC) System for Wilderness Planning. United States Department of Agriculture, Forest Service. General Technical Report INT-176.

U.S. Army Corps of Engineers. 1993. Draft Environmental Impact Statement. Cumulative Impacts of Recreational Boating on the Fox River and Chain O' Lakes Area in Lake and McHenry Counties, Illinois. USA Corps of Engineers, Chicago District.

METHODS

9

ECOSYSTEM ANALYSIS

Ecosystem analysis involves considering the full range of ecological resources and their interactions with the environment. This approach can improve cumulative effects analysis by *providing the broad regional perspective and holistic thinking needed to address the following cumulative effects principles*:

- **Focus on the resource or ecosystem.** Ecosystem analysis specifically addresses biodiversity and uses the full range of indicators of ecological conditions ranging from the genetic to species to local ecosystem to regional ecosystem levels.
- **Use natural boundaries.** Ecosystem analysis uses ecological regions, such as watersheds and ecoregions, to encompass ecosystem functioning and landscape-scale phenomena such as habitat fragmentation.
- **Address resource or ecosystem sustainability.** The ecosystem approach to management explicitly addresses the ecological interactions and processes necessary to sustain ecosystem composition, structure, and function (Ad Hoc Committee on Ecosystem Management 1995).

Traditionally, environmental impact assessment has considered air quality, water resources, wildlife, and human communities as separate entities for analysis. This separation of resources has obscured many cumulative effects. Recognition of the interconnectedness of land, water, and human resources has driven many federal and state agencies to undertake eco-

system or watershed approaches to environmental protection. Since 1991, the U.S. EPA (1996) has embraced the watershed approach as the major mechanism for addressing cumulative nonpoint-source pollution. Specific applications include watershed-based TMDLs (U.S. EPA 1994) and the "watershed analysis" approach to addressing cumulative effects and improving resource management on timber land (Washington State Department of Natural Resources 1992; Regional Interagency Executive Committee 1995).

By its nature, biodiversity conservation is a cumulative effects issue. Because it encompasses all the structural and functional components of the biological environment (and its interactions with the physical world), biodiversity is constantly affected by a wide range of stresses. For this reason, the goals of biodiversity and ecosystem protection are usually coincident with those of cumulative effects analysis; therefore, the analyst should employ an ecosystem approach whenever biodiversity is an issue.

Principles of the ecosystem approach are included CEQ's (1993) report, *Incorporating Biodiversity Considerations Into Environmental Impact Analysis Under the National Environmental Policy Act* (see box) and the Interagency Ecosystem Management Task Force's (1995) report, *The Ecosystem Approach: Healthy Ecosystems and Sustainable Economics*. These principles involve three basic concepts: (1) taking a "big picture" or landscape-level view of ecosystems, (2) using a diverse suite of indicators including community-level and ecosystem-level

METHODS

indices, and (3) addressing the myriad interactions among ecological components that are needed to sustain ecosystem functioning. Applying the ecosystem approach to cumulative effects analysis entails using biological indicators (e.g., indices of biotic integrity for surface waters; K a r r 1 9 9 1 ; U . S .

EPA 1990) as integrators of cumulative effects and landscape indices (e.g., patch distribution of wetlands; Preston and Bedford 1988; Leibowitz et al. 1992) as measures of the cumulative diminution of ecosystem functioning. Natural resource agencies may soon be able to provide guidance on assessing and mitigating environmental effects at the ecosystem level (Truett et al. 1994).

PRINCIPLES OF BIODIVERSITY CONSERVATION (CEQ 1993)

1. Take a "big picture" or ecosystem view.
2. Protect communities and ecosystems.
3. Minimize fragmentation.
Promote the natural pattern and connectivity of habitats.
4. Promote native species.
Avoid introducing non-native species.
5. Protect rare and ecologically important species.
6. Protect unique or sensitive environments.
7. Maintain or mimic natural ecosystem processes.
8. Maintain or mimic naturally occurring structural diversity.
9. Protect genetic diversity.
10. Restore ecosystems, communities, and species.
11. Monitor for biodiversity impacts.
Acknowledge uncertainty.
Be flexible.

METHODS

9 EXAMPLES:

Constructing precise models of ecosystem structure and function sometimes exceeds the capabilities of NEPA practitioners. Considerable progress, however, has been made in applying the principles of ecosystem analysis to analyzing cumulative effects by extending considerations beyond species to the ecosystem and by looking at landscape-scale processes such as habitat fragmentation.

The most celebrated example where ecosystem analysis was used to extend the analysis of cumulative effects beyond a single species is the *Supplemental Environmental Impact Statement on Management of Habitat for Late-Successional and Old-Growth Forest Related Species Within the Range of the Northern Spotted Owl* (U.S. Forest Service and Bureau of Land Management 1993). Expert panels were convened to determine the likelihood of maintaining viable populations of a comprehensive suite of species and groups of species based on available habitat. Addressing the entire ecosystem involved considering terrestrial forest ecosystems (i.e., amounts of late-successional and old-growth forests and the viability of species ranging from fungi to bats), aquatic ecosystems (habitat conditions, riparian ecosystem processes), and aquatic and riparian dependent organisms (e.g., anadromous salmonids, resident fish species and subspecies, and other aquatic, riparian, and wetland organisms). The U.S. Forest Service (in conjunction with the U.S. Bureau of Land Management and Food and Drug Administration) also incorporated ecosystem analysis into the *Pacific Yew Final Environmental Impact Statement* by defining the role of the Pacific yew in the forest ecosystem (Figure A-11; U.S. Forest Service 1993). The cumulative effects of harvesting Pacific yew

on federal lands in the Pacific northwest for taxol production (for use as a cancer treatment) were analyzed in three different contexts: the Pacific yew itself (including its genetic diversity), the forest ecosystem that supports yew populations, and the relationship of the yew and human communities.

The ecosystem analysis approach implemented by the Forest Ecosystem Assessment Team (FEMAT) in the spotted owl EIS also considered ecosystem processes affected by the cumulative actions on lands owned and managed by states, tribes, corporations, individuals, and other nonfederal agencies. The analysis included an aquatic conservation strategy based on the designation of key watersheds and the use of watershed analysis. The Washington State Department of Natural Resources (1992) recently published a watershed analysis manual including a set of technically rigorous procedures that can be used to determine what processes are active in a watershed, how these processes are distributed in time and space, what the current upland and riparian conditions are, and how all of these factors influence ecosystem services or other beneficial uses. Watershed analysis is being expanded to encompass other aspects of the ecosystem approach to management (Montgomery et al. 1995; Regional Interagency Executive Committee 1995). In the **synoptic landscape approach** to cumulative effects analysis developed by the U.S. EPA Environmental Research Laboratory in Corvallis, OR, the landscape is the unit of analysis (Leibowitz et al. 1992). Synoptic indices are chosen from the following landscape-level measures: function value, functional loss, and replacement potential. Subsequently, landscape indicators are chosen as

METHODS

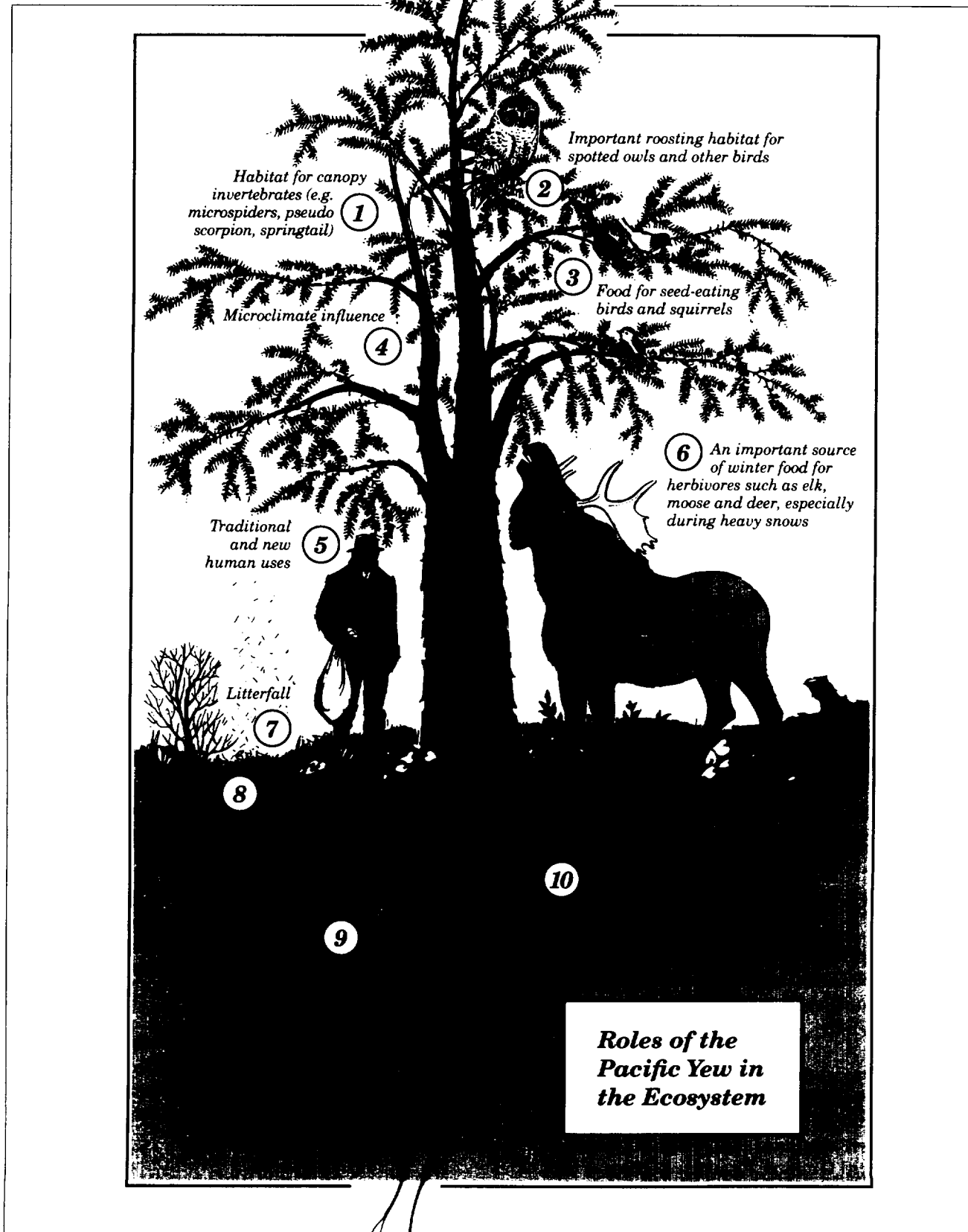

Figure A-11. Roles of the Pacific Yew in the Ecosystem (U.S. Forest Service 1993)

METHODS

first-order approximations of the synoptic indices. This approach provides a framework for comparing the cumulative effects of actions on landscape processes such as flood storage and wildlife support.

Habitat fragmentation is one of the most important ecosystem-level processes to address in cumulative effects analysis. Concerns about potential cumulative effects of habitat fragmentation on biodiversity prompted a supplemental information report to the FEIS and Record of Decision (ROD) of the Trail Creek Timber Sale, Beaverhead National Forest, Montana (U.S. Forest Service 1991). The report assessed habitat loss effects, edge effects, patch size effects, insularity effects (on genetics of populations linked by habitat corridors), and effects on rare elements. Specifically, the report evaluated the importance of the area as a biological corridor between the large wildland areas of the Northern Continental Divide, Selway-Bitterroot, and Greater Yellowstone areas. Similar concerns have been raised in other areas (e.g., Klamath National Forest; Pace 1990) and have prompted considerable research into landscape-level indicators such as abundance or density of habitats, habitat proportion, patch size and perimeter-to-area ratio, fractal dimension (amount of edge), and contagion or habitat patchiness (Hunsaker and Carpenter 1990; Noss 1990; O'Neill et al. 1994).

References

- Ad Hoc Committee on Ecosystem Management. 1995. *The Scientific Basis for Ecosystem Management*. Ecological Society of America, Washington, DC.
- Council on Environmental Quality (CEQ). 1993. *Incorporating Biodiversity Considerations Into Environmental Impact Analysis Under the National Environmental Policy Act*. Council on Environmental Quality, Executive Office of the President, Washington, DC. 29 pp.
- Hunsaker, C.T. and D.E. Carpenter. 1990. *Environmental Monitoring and Assessment Program—Ecological Indicators*. U.S. Environmental Protection Agency, Research Triangle Park, NC. EPA 600/3-90/060.
- Interagency Ecosystem Management Task Force. 1995. *The Ecosystem Approach: Healthy Ecosystems and Sustainable Economies, Vol. I Overview*. Washington, DC.
- Karr, J.R. 1991. Biological Integrity: A Long-Neglected Aspect of Water Resource Management. *Ecological Applications* 1:66-84.
- Leibowitz, S.G., B. Abbruzzese, P. Adamus, L. Hughes, and J. Irish. 1992. A Synoptic Approach to Cumulative Impact Assessment—A Proposed Methodology. U.S. Environmental Protection Agency, Environmental Research Laboratory, Corvallis, OR. EPA/600/R-92/167.
- Montgomery, D.R., G.E. Grant, and K. Sullivan. 1995. Watershed analysis as a framework for implementing ecosystem management. *Water Resources Bulletin* 31(3):369-386.
- Noss, R.F. 1990. Indicators for monitoring biodiversity: a hierarchical approach. *Conservation Biology* 4:355-364.
- O'Neill, R.V., K.B. Jones, K.H. Riitters, J.D. Wickham, and I.A. Goodman. 1994. *Landscape Monitoring and Assessment Plan*. U.S. Environmental Protection Agency, Las Vegas, NV. EPA/620/R-94/009.
- Pace, F. 1990. The Klamath Corridors: Preserving biodiversity in the Klamath National Forest. In: Hudson, W.E., ed. *Landscape Linkages and Biodiversity*. Island Press, Washington, DC, pp. 105-106.
- Preston, E.M. and B.L. Bedford. 1988. Evaluating cumulative effects on wetland functions: A conceptual overview and generic framework. *Environmental Management* 12:565-583.

METHODS

Regional Interagency Executive Committee. 1995. Ecosystem Analysis of the watershed scale: Federal guide for watershed analysis - Version 2.2. Regional Ecosystem Office, Portland, OR. 26 pp.

Truett, J.C., H.L. Short, and S.C. Williamson. 1994. Ecological impact assessment. In: T.A. Bookhout, ed. *Research and Management Techniques For Wildlife and Habitats*. The Wildlife Society, Bethesda, MD pp. 607-622.

U.S. Environmental Protection Agency (EPA). 1990. Biological Criteria: National Program Guidance for Surface Waters. U.S. EPA, Office of Water Regulations and Standards, Washington, DC. EPA-440/5-90-004.

U.S. Environmental Protection Agency. 1994. Moving the NPDES Program to a Watershed Approach. Office of Wastewater Management, Washington, D.C. EPA 833-R-96-001.

U.S. Environmental Protection Agency (EPA). 1996. Watershed Events: A Bulletin on Sustaining Aquatic Ecosystems. Spring. U.S. EPA, Office of Water, Washington, DC. EPA 840-N-96-002.

U.S. Forest Service. 1991. Supplemental information report, Trail Creek Timber Sale, Wisdom Ranger District, Beaverhead National Forest. USDA, Forest Service, Northern Region. April 2.

U.S. Forest Service. 1993. Pacific Yew Final Environmental Impact Statement. USDA, Forest Service, Pacific Northwest Regional Office, Portland, OR.

U.S. Forest Service and Bureau of Land Management. 1993. *Draft Supplemental Environmental Impact Statement on Management of Habitat for Late-Successional and Old-Growth Forest Related Species Within the Range of the Northern Spotted Owl*. Portland, OR. July.

Washington State Department of Natural Resources. 1992. Watershed Analysis Manual. Version 1.0. Timber, Fish, and Wildlife, Olympia, WA. TFW-CEI-92-002.

METHODS

10

ECONOMIC IMPACT ANALYSIS

Economic impact analysis satisfies the mandate under NEPA to "...fulfill the social, economic and other requirements of present and future generations of Americans" [National Environmental Policy Act, Title I Sec. 101 (a)]. *It is an important component of analyzing cumulative effects, because the economic well-being of a local community depends on many different actions.* The following effects are the minimum that an economic impact analysis should determine:

- change in business activity
- change in employment
- change in income
- changes in population.

The three primary steps in conducting an economic impact analysis are (1) establishing the region of influence, (2) modeling the economic effects, and (3) determining the significance of the effects.

The definition of the geographic region of influence (ROI) is often controversial. Most regional and urban analysts prefer to use a functional area concept for defining study regions (Fox and Kuman 1965). Regions defined in this way explicitly consider the economic linkages between the residential population and the businesses in the geographic area. Specifically, the affected region should include all of the self-sustaining ingredients of region-local businesses, local government, and local population (Chalmers and Anderson 1977). Although no standard methodology exists, the definition of a ROI should consider residence patterns of the affected population,

availability of local shopping opportunities, "journey-to-work" time for employees, and local customs and culture.

Economic models are invaluable for analyzing cumulative effects. The suite of economic models can vary from simple to complex (Richardson 1985; Treyz 1993). As a rule, economic models are sets of mathematical equations that represent the interactions among the integral components of the regional economy; the modeled relationships are based upon economic principals that have a long history of accuracy and use. Data to "drive" the models are critical to performing an impact analysis and acquiring data is often the limiting factor for the analyst. Although they are focused on economic relationships, economic models can incorporate demographics. Ultimately, economic models are used to project effects under each alternative.

Once model effects projections are obtained, additional tools, such as the rational threshold value (RTV) and the forecast significance of impacts (FSI) approaches, can provide timely and cost-effective evaluations of the significance of the effect (Huppertz and Bloomquist 1993). These analytical tools review the historical trends for the defined region and develop measures of historical fluctuations in sales activity, employment, income, and population. This use of time-series data provides the analyst with a historical context in which to evaluate significance. The use of economic impact models in combination with the RTV and FSI techniques has proven successful in addressing cumulative economic impacts.

METHODS

10 EXAMPLES:

Three kinds of models are most often used in economic impact analysis: economic base models, input-output models, and econometric models. The underlying assumption of an economic base model is that changes in a regional economy occur as a result of changes in the amounts of goods and services that are sold outside the region. The economic base model is based on the bifurcation of the regional economy into "basic" and "non-basic" sectors. Defined simply, basic sectors produce goods and services that are generally consumed outside the region and non-basic sectors produce goods and services that are consumed within the region. Basic sectors can be identified by surveying local firms and households to determine where they purchase their goods and services or by the "location-quotient" technique (Isserman 1977), which measures the extent to which a sector is more concentrated within the region than within the nation as a whole. The location-quotient assumes this excess production is exported outside the region.

Input-output models (Miller and Blair 1985) explicitly consider the interrelationships between different sectors of a regional economy and how these interactions affect the process of economic changes within the region. Input-output models provide more information on economic transactions by sector within a local economy than economic base models, but they require more data. Regional econometric models (Glickman 1977; Treyz 1993) represent a compromise between economic base and input-output analysis in terms of data requirements and information produced. Econometric models are usually statistically derived and draw upon survey-based data, traditional regression techniques, and other statistical tools. Fluctuations in the subject regional economies, respectively. The total aggregate changes in business volume, employment, income, and population (four of the model outputs) are then used

Econometric models use time-series data to show the pattern of effects due to outside influences over a period of years. As a result, regional econometric models are better suited for predictions of long-run effects. Unfortunately, local-time series data are often not available for the region of concern.

The Economic Impact Forecast System (EIFS) is perhaps the most commonly used method for assessing regional economic effects; it is the specified model of choice for all environmental analyses associated with Army Base Realignment and Closure (BRAC). EIFS was developed as a simple model based upon three major criteria: (1) basis in sound theory, (2) acceptance by the scientific community, and (3) availability of data to drive the model. By entering county names to designate the Region of Economic Influence (ROI), Bureau of Economic Analysis (BEA) and other data are readily available for use. After six variables associated with the action [i.e., number of military and civilian employees being transferred, the average salary of both categories, the percent of military personnel living on base, and the anticipated change in local (or total) procurements] are added to the thousands of BEA data elements, EIFS automatically performs the needed trends analysis, multiplier calculations, and other computations. EIFS has provided a consistent methodology for all BRAC studies and has allowed the Army to "rank-order impacts" among alternatives as required by NEPA.

The significance of BRAC actions is determined by adding two evaluative components to EIFS. As described previously, RTV and FSI techniques measure historical and statistical

to assess the significance of regional economic effect. As analysts begin to address the cumulative effects of more and more actions,

METHODS

other models that lead directly from available data to conclusions of significance will be needed.

References

Chalmers, J.A. and E.J. Anderson. 1977. Economic/Demographic Assessment Manual: Current Practices, Procedural Recommendations, and a Test Case. U.S. Bureau of Reclamation. Denver, Colorado.

Fox, K.A. and T.K. Kuman. 1965. The functional economic area: Delineation and implications for economic analysis and policy. *Papers and Proceedings, Regional Science Association* 15: 57-85.

Glickman, N.J. 1977. *Econometric Analysis of Regional Systems*. New York: Academic Press.

Huppertz, C.E. and K. M. Bloomquist. 1993. Economic Impact Forecast System (EIFS): Guide to Economic Models and Software Version 4.1, Draft CERL Technical Report. Department of the Army, Construction Engineering Research Laboratories, Champaign, Illinois.

Isserman, A.M. 1977. The location quotient approach to estimating regional economic impact. *Journal of American Institute of Planners*, January 1977, 33-41.

Miller, R.E. and P.D. Blair. 1985. *Input-Output Analysis: Foundations and Extensions*. Prentice-Hall, Inc. Englewood Cliffs, New Jersey.

Richardson, H.W. 1985. Input-output and economic base multipliers: Looking backward and forward. *Journal of Regional Science* 25: 607-661.

Treyz, G.I. 1993. *Regional Economic Modeling: A Systematic Approach to Economic Forecasting and Policy Analysis*. Kluwer Academic Publishers, Boston, Massachusetts.

METHODS

11

SOCIAL IMPACT ANALYSIS

Social impact analysis fulfills the mandate under CEQ's regulations that the "human environment" in NEPA be "interpreted comprehensively" to include "the natural and physical environment and the relationship of people with the environment" (40 CFR§ 1508.14). The social sciences have *made considerable progress in addressing cumulative effects related to environmental stewardship by focusing on key social impact variables*. The Interorganizational Committee on Guidelines and Principles (1994) has identified five basic categories of social impact variables:

1. Population characteristics such as its size and expected size, ethnic and racial diversity, and the influx and outflux of temporary (e.g., seasonal or leisure) residents.
2. Community and institutional structures including the size, structure, and linkages of local government; the historical and present patterns of employment and industrial diversification; and the size, activity, and interactions of voluntary associations, religious organizations, and interest groups.
3. Political and social resources such as the distribution of power and authority, the identification of interested and affected parties, and the leadership capacity within the community or region.
4. Individual and family changes including factors that influence the daily life of individuals and families (and indigenous and religious subcultures) in the community or region such as attitudes toward the proposed policy, alterations in family and community networks, and perceptions of risk, health, and safety.
5. Community resources such as patterns of natural resource and land use; the availability of housing; and community services including health, police, fire protection, and sanitation facilities.

The key to analyzing the cumulative effects on these social impact variables is incorporating multiple actions into projections of future social conditions. The following general categories describe the range of methods used to predict future social effects:

- linear trend projections (identifying taking an existing trend and projecting the same rate of change into the future);
- population multiplier methods (a specified increase in population implies designated multiples of some other variable);
- scenarios (characterization of hypothetical futures through a process of mathematically or schematically modeling the assumptions about the variables in question);
- expert testimony (experts can be asked to develop scenarios and assess their implications);
- simulation modeling (mathematical formulation of premises and a process of quantitatively weighing variables).

METHODS

11 EXAMPLES:

Social impact analysis differs from other analyses of cumulative effects because it must deal with the subjective perception of effects. Social effects appraisal and social well-being accounts are examples of methods for analyzing subjective social variables.

Social effects appraisal determines the social meaning and significance of the objective changes produced by cumulative actions. The social analyst assesses the social meaning of the changes from the different perspectives of the affected groups. One way to measure the meaning of a change is to tap the knowledge of opinion leaders (formally or informally) within the affected groups to determine the values they assign to each change. For example, an influx of 200 construction workers and their families might be viewed positively by families suffering from a stagnant economy but negatively by retirees looking for a quiet neighborhood. The social analyst needs to acknowledge that while some negative social effects can be remedied materially (perhaps by economic growth), others are qualitative and defy mitigation.

The social well-being account is a display that summarizes findings by cross tabulating levels of analysis, evaluation categories, and effect factors with a social effects evaluation of the present condition and each of the alternatives (including no-action). It provides either a quantitative (numerical) or qualitative rating of each alternative's overall social effect and a description of the rating scale. The Multi-Attribute Tradeoff System (MATS) and other computer programs assist in producing a systematic numerical evaluation of social effects. The result is an overall quantitative ranking for

each alternative, reflecting the alternative's relative social benefit to the affected group.

The Federal Highway Administration (FHWA) frequently deals with social impact issues related to its transportation projects. FHWA (1996) recently prepared a primer for analysts who assess the effects of proposed transportation actions on human communities. FHWA states that community impact studies must include secondary effects and influences from outside developmental pressures to determine the ability of an area to survive removal of housing, businesses, and community services. Also, such studies must describe a community's ability to absorb relocated residents and businesses in terms of social and economic disturbance (e.g., available housing, public services affected, areas zoned for business use). The primer describes nine impact categories to be analyzed, including social and psychological aspects, physical aspects, visual environment, land use, economic conditions, mobility and access, provision of public services, safety, and displacement. Considering these effects naturally includes environmental justice issues. Community impact analysis is analogous to ecosystem analysis in that the human community should be thought of as an integral unit with a characteristic social setting and operation. Decisions about avoiding and mitigating effects should be based on consensus visions of the desired condition of the community. Lastly, if community effects are to receive attention comparable to that given the natural environment, special effort to ensure public involvement must be employed (e.g., using nontraditional and informal approaches).

References

METHODS

Federal Highway Administration (FHWA). 1996. Community Impact Assessment: A Quick Reference for Transportation. FHWA, Office of Environmental and Planning, Washington, DC. FHWA-PD-96, HEP-30.

Interorganizational Committee on Guidelines and Principles. 1994. Guidelines and principles for social impact assessment. *Impact Assessment* 12(2):107-152.

METHODS

APPENDIX B

ACKNOWLEDGEMENTS

ACKNOWLEDGEMENTS

Many people contributed to this handbook. Members of an interdisciplinary team, each with experience in the art and science of environmental impact assessment and the National Environmental Policy Act, provided input to the process, contributing ideas, examples, and energy. The project was directed by Ray Clark, Director of NEPA Oversight, Council on Environmental Quality. The Federal Highway Administration, Federal Energy Regulatory Commission, Department of the Army, U.S. Forest Service, National Park Service, and U.S. Environmental Protection Agency provided funding for this interagency effort. As the primary authors, the following individuals invested the greatest amount of time and effort in producing this handbook – Mark Southerland, Patti Leppert-Slack, Elizabeth Ann Stull, Kirk LaGory, Matt McMillen, Chuck Herrick, Margo Burnham, Gene Cleckley, Allison Cook, Bill Cork, Tom Russo, Dave Somers, Wendell Stills, Ron Webster, and Bob Wheeler. The addresses of these and other contributors are listed below. The handbook was peer-reviewed in draft by a group of academicians and practitioners coordinated by Richard Carpenter (listed on the last page). Their comments and those of many others provided valuable input into the handbook. We thank all who contributed to this effort.

Contributors

Gene Cleckley
Fred Skaer
Wendell Stills
Bob Wheeler
Federal Highway Administration
400 7th Street, SW, Room 3301
Washington, D.C. 20590
(202) 366-2029

Allison Cook
1305 East Capitol Street, SE Apt. #2
Washington, DC 20003

William V. Cork
ICF Kaiser International, Inc.
21515 Great Mills Road
Lexington Park, MD 20653
(301) 866-2020

Robert Cunningham
Office of Polar Programs
National Science Foundation
4201 Wilson Blvd., Suite 755
Arlington, VA 22230
(703) 306-1031

Peggy Currid
Robert Eltzholtz
Coe-Truman Technologies
206 Burwash Avenue
Savoy, IL 61874
(217) 398-8594

William Dickerson
Pat Haman
Anne Miller
Jim Serfis
U.S. Environmental Protection Agency
401 M Street, SW, MC-2252
Washington, D.C. 20460
(202) 564-2410

John Farrell, Retired
Office of Environmental Affairs
U.S. Department of the Interior
1849 C Street N.W.
Washington, D.C. 20240
(202) 208-7116

Horst Greczmiel
U.S. Coast Guard
2100 Second Street, SW
Washington, D.C. 20593
(202) 267-0053

Charles Herrick, Ph.D.
Margo Burnham
Meridian Corporation
4300 King Street, Suite 400
Alexandria, VA 22308-1508
(703) 998-3600

ACKNOWLEDGEMENTS

Jake Hoogland
Environmental Compliance Division
Planning and Development
National Parks Service
U.S. Department of the Interior
Main Interior Building, Room 1210
1849 C Street, N.W.
Washington, D.C. 20240
(202) 208-3163

David Ketcham
Environmental Coordination Division
U.S. Department of Agriculture, Forest Service
291 14th Street S.W., 5th Floor, South Wing
Washington, D.C. 20250
(202) 205-1708

Kirk LaGory, Ph.D.
Elisabeth Ann Stull
Argonne National Laboratory
9700 South Cass Avenue
Argonne, IL 60439
(630) 252-3169
(603) 252-7169

Patrice "Pat" LeBlanc
Carmen Drouin
Federal Environmental Assessment Review Office
Government of Canada
13th Floor, Fontaine Building
Hull, Quebec, Canada K1A 0H3
(819) 953-2530

Phil Mattson
Planning and Environmental Affairs
USDA Forest Service
333 Southwest First Avenue
P.O. Box 3623
Portland, OR 97802-3865
(503) 326-3865

Matt McMillen
Energetics Corporation
501 School Street, SW
Suite 440
Washington, D.C. 22024
(202) 479-2747

Paul Petty
Bureau of Land Management
2850 Youngfield Street
Lakewood, CO 80215
(303) 239-3736

Dennis Robinson, Ph.D.
Department of the Army,
Corps of Engineers
Water Resources Support Center
7701 Telegraph Road
Casey Building
Alexandria, VA 22310-3868
(703) 355-3092

Thomas N. Russo
Patti Leppert-Slack
Federal Energy Regulatory Commission
888 First Street, NE
Washington, D.C. 20426
(202) 219-2792
(202) 219-2767

Dave Somers
The Tulalip Tribes
3901 Totem Beach Road
Marysville, WA 98270-9694
(206) 653-0220

Mark Southerland, Ph.D.
Versar, Inc.
9200 Rumsey Road
Columbia, MD 21045-1934
(410) 964-9200

Ron Webster
Robert Lozar
Department of the Army -
CERL
2902 Newmark Drive
Champaign, IL 61821-1706
1-800-872-2375

Dick Wilderman
Branch of Environmental Projects Coordination
Minerals Management Service
381 Eldon Street, Mail Stop 4320
Herndon, VA 22070
(703) 787-1670

Gary Williams, Ph.D.
Argonne National Laboratory
955 L'Enfant Plaza North, S.W.
Suite 6000
Washington, D.C. 20024
(202) 488-2418

ACKNOWLEDGEMENTS

Peer Review Panel

Richard Carpenter
Rt. 5, Box 277
Charlottesville, VA 22901

Mark Bain, Ph.D.
Cornell University
Department of Natural Resources
208A Fernow Hall
Ithaca, NY 14853

Larry W. Canter, Ph.D.
University of Oklahoma
Environmental and Groundwater Institute
200 Felgar Street, Room 127
Norman, OK 73019-0470

Cheryl Contant, Ph.D.
University of Iowa
Department of Urban and Regional Planning
347 Jefferson Hall
Iowa City, IA 52242-1316

Alex Hoar
U.S. Fish and Wildlife Service
300 Westgate Center Drive
Hadley, MA 01035-9589

Lance McCold
Oak Ridge National Laboratory
P.O. Box 2008
Oak Ridge, TN 37831-6206

B.J. Quinn
North Carolina Department of Transportation
Planning and Environmental Branch
P.O. Box 25201
Raleigh, NC 27611-2501

Michael V. Stimac
HDR Engineering
500 108th Avenue, Suite 1200
Bellevue, WA 98004